

User's Manual



MAV 44 / 48 / 84 / 88 Series

Matrix Switchers

Precautions

Safety Instructions • English



This symbol is intended to alert the user of important operating and maintenance (servicing) instructions in the literature provided with the equipment.



This symbol is intended to alert the user of the presence of uninsulated dangerous voltage within the product's enclosure that may present a risk of electric shock.

Caution

Read Instructions • Read and understand all safety and operating instructions before using the equipment.

Retain Instructions • The safety instructions should be kept for future reference.

Follow Warnings • Follow all warnings and instructions marked on the equipment or in the user information.

Avoid Attachments • Do not use tools or attachments that are not recommended by the equipment manufacturer because they may be hazardous.

Consignes de Sécurité • Français



Ce symbole sert à avertir l'utilisateur que la documentation fournie avec le matériel contient des instructions importantes concernant l'exploitation et la maintenance (réparation).



Ce symbole sert à avertir l'utilisateur de la présence dans le boîtier de l'appareil de tensions dangereuses non isolées posant des risques d'électrocution.

Attention

Lire les instructions • Prendre connaissance de toutes les consignes de sécurité et d'exploitation avant d'utiliser le matériel.

Conservier les instructions • Ranger les consignes de sécurité afin de pouvoir les consulter à l'avenir.

Respecter les avertissements • Observer tous les avertissements et consignes marqués sur le matériel ou présentés dans la documentation utilisateur.

Eviter les pièces de fixation • Ne pas utiliser de pièces de fixation ni d'outils non recommandés par le fabricant du matériel car cela risquerait de poser certains dangers.

Sicherheitsanleitungen • Deutsch



Dieses Symbol soll dem Benutzer in der im Lieferumfang enthaltenen Dokumentation besonders wichtige Hinweise zur Bedienung und Wartung (Instandhaltung) geben.



Dieses Symbol soll den Benutzer darauf aufmerksam machen, daß im Inneren des Gehäuses dieses Produktes gefährliche Spannungen, die nicht isoliert sind und die einen elektrischen Schock verursachen können, herrschen.

Achtung

Lesen der Anleitungen • Bevor Sie das Gerät zum ersten Mal verwenden, sollten Sie alle Sicherheits- und Bedienungsanleitungen genau durchlesen und verstehen.

Aufbewahren der Anleitungen • Die Hinweise zur elektrischen Sicherheit des Produktes sollten Sie aufbewahren, damit Sie im Bedarfsfall darauf zurückgreifen können.

Befolgen der Warnhinweise • Befolgen Sie alle Warnhinweise und Anleitungen auf dem Gerät oder in der Benutzerdokumentation.

Keine Zusatzgeräte • Verwenden Sie keine Werkzeuge oder Zusatzgeräte, die nicht ausdrücklich vom Hersteller empfohlen wurden, da diese eine Gefahrenquelle darstellen können.

Instrucciones de seguridad • Español



Este símbolo se utiliza para advertir al usuario sobre instrucciones importantes de operación y mantenimiento (o cambio de partes) que se desean destacar en el contenido de la documentación suministrada con los equipos.



Este símbolo se utiliza para advertir al usuario sobre la presencia de elementos con voltaje peligroso sin protección aislante, que puedan encontrarse dentro de la caja o alojamiento del producto, y que puedan representar riesgo de electrocución.

Precaucion

Leer las instrucciones • Leer y analizar todas las instrucciones de operación y seguridad, antes de usar el equipo.

Conservar las instrucciones • Conservar las instrucciones de seguridad para futura consulta.

Obedecer las advertencias • Todas las advertencias e instrucciones marcadas en el equipo o en la documentación del usuario, deben ser obedecidas.

Evitar el uso de accesorios • No usar herramientas o accesorios que no sean específicamente recomendados por el fabricante, ya que podrían implicar riesgos.

安全须知 • 中文



这个符号提示用户该设备用户手册中有重要的操作和维护说明。



这个符号警告用户该设备机壳内有暴露的危险电压，有触电危险。

注意

阅读说明书 • 用户使用该设备前必须阅读并理解所有安全和使用说明。

保存说明书 • 用户应保存安全说明书以备将来使用。

遵守警告 • 用户应遵守产品和用户指南上的所有安全和操作说明。

避免追加 • 不要使用该产品厂商没有推荐的工具或追加设备，以避免危险。

Warning

Power sources • This equipment should be operated only from the power source indicated on the product. This equipment is intended to be used with a main power system with a grounded (neutral) conductor. The third (grounding) pin is a safety feature, do not attempt to bypass or disable it.

Power disconnection • To remove power from the equipment safely, remove all power cords from the rear of the equipment, or the desktop power module (if detachable), or from the power source receptacle (wall plug).

Power cord protection • Power cords should be routed so that they are not likely to be stepped on or pinched by items placed upon or against them.

Servicing • Refer all servicing to qualified service personnel. There are no user-serviceable parts inside. To prevent the risk of shock, do not attempt to service this equipment yourself because opening or removing covers may expose you to dangerous voltage or other hazards.

Slots and openings • If the equipment has slots or holes in the enclosure, these are provided to prevent overheating of sensitive components inside. These openings must never be blocked by other objects.

Lithium battery • There is a danger of explosion if battery is incorrectly replaced. Replace it only with the same or equivalent type recommended by the manufacturer. Dispose of used batteries according to the manufacturer's instructions.

Avertissement

Alimentations • Ne faire fonctionner ce matériel qu'avec la source d'alimentation indiquée sur l'appareil. Ce matériel doit être utilisé avec une alimentation principale comportant un fil de terre (neutre). Le troisième contact (de mise à la terre) constitue un dispositif de sécurité : n'essayez pas de la contourner ni de la désactiver.

Déconnexion de l'alimentation • Pour mettre le matériel hors tension sans danger, déconnectez tous les cordons d'alimentation de l'arrière de l'appareil ou du module d'alimentation de bureau (s'il est amovible) ou encore de la prise secteur.

Protection du cordon d'alimentation • Acheminer les cordons d'alimentation de manière à ce que personne ne risque de marcher dessus et à ce qu'ils ne soient pas écrasés ou pincés par des objets.

Réparation-maintenance • Faire exécuter toutes les interventions de réparation-maintenance par un technicien qualifié. Aucun des éléments internes ne peut être réparé par l'utilisateur. Afin d'éviter tout danger d'électrocution, l'utilisateur ne doit pas essayer de procéder lui-même à ces opérations car l'ouverture ou le retrait des couvercles risquent de l'exposer à de hautes tensions et autres dangers.

Fentes et orifices • Si le boîtier de l'appareil comporte des fentes ou des orifices, ceux-ci servent à empêcher les composants internes sensibles de surchauffer. Ces ouvertures ne doivent jamais être bloquées par des objets.

Lithium Batterie • Il a danger d'explosion s'il y a remplacement incorrect de la batterie. Remplacer uniquement avec une batterie du même type ou d'un type équivalent recommandé par le constructeur. Mettre au rebut les batteries usagées conformément aux instructions du fabricant.

Vorsicht

Stromquellen • Dieses Gerät sollte nur über die auf dem Produkt angegebene Stromquelle betrieben werden. Dieses Gerät wurde für eine Verwendung mit einer Hauptstromleitung mit einem geerdeten (neutralen) Leiter konzipiert. Der dritte Kontakt ist für einen Erdschluß, und stellt eine Sicherheitsfunktion dar. Dieses sollte nicht umgangen oder außer Betrieb gesetzt werden.

Stromunterbrechung • Um das Gerät auf sichere Weise vom Netz zu trennen, sollten Sie alle Netzkabel aus der Rückseite des Gerätes, aus der externen Stromversorgung (falls dies möglich ist) oder aus der Wandsteckdose ziehen.

Schutz des Netzkabels • Netzkabel sollten stets so verlegt werden, daß sie nicht im Weg liegen und niemand darauf treten kann oder Objekte darauf- oder unmittelbar dagegengestellt werden können.

Wartung • Alle Wartungsmaßnahmen sollten nur von qualifiziertem Servicepersonal durchgeführt werden. Die internen Komponenten des Gerätes sind wartungsfrei. Zur Vermeidung eines elektrischen Schocks versuchen Sie in keinem Fall, dieses Gerät selbst öffnen, da beim Entfernen der Abdeckungen die Gefahr eines elektrischen Schlags und/oder andere Gefahren bestehen.

Schlitze und Öffnungen • Wenn das Gerät Schlitze oder Löcher im Gehäuse aufweist, dienen diese zur Vermeidung einer Überhitzung der empfindlichen Teile im Inneren. Diese Öffnungen dürfen niemals von anderen Objekten blockiert werden.

Lithium-Batterie • Explosionsgefahr, falls die Batterie nicht richtig ersetzt wird. Ersetzen Sie verbrauchte Batterien nur durch den gleichen oder einen vergleichbaren Batterietyp, der auch vom Hersteller empfohlen wird. Entsorgen Sie verbrauchte Batterien bitte gemäß den Herstelleranweisungen.

Advertencia

Alimentación eléctrica • Este equipo debe conectarse únicamente a la fuente/tipo de alimentación eléctrica indicada en el mismo. La alimentación eléctrica de este equipo debe provenir de un sistema de distribución general con conductor neutro a tierra. La tercera pata (puesta a tierra) es una medida de seguridad, no puentearla ni eliminarla.

Desconexión de alimentación eléctrica • Para desconectar con seguridad la acometida de alimentación eléctrica al equipo, desenchufar todos los cables de alimentación en el panel trasero del equipo, o desenchufar el módulo de alimentación (si fuera independiente), o desenchufar el cable del receptáculo de la pared.

Protección del cables de alimentación • Los cables de alimentación eléctrica se deben instalar en lugares donde no sean pisados ni apretados por objetos que se puedan apoyar sobre ellos.

Reparaciones/mantenimiento • Solicitar siempre los servicios técnicos de personal calificado. En el interior no hay partes a las que el usuario deba acceder. Para evitar riesgo de electrocución, no intentar personalmente la reparación/mantenimiento de este equipo, ya que al abrir o extraer las tapas puede quedar expuesto a voltajes peligrosos u otros riesgos.

Ranuras y aberturas • Si el equipo posee ranuras o orificios en su caja/alojamiento, es para evitar el sobrecalentamiento de componentes internos sensibles. Estas aberturas nunca se deben obstruir con otros objetos.

Batería de litio • Existe riesgo de explosión si esta batería se coloca en la posición incorrecta. Cambiar esta batería únicamente con el mismo tipo (o su equivalente) recomendado por el fabricante. Desachar las baterías usadas siguiendo las instrucciones del fabricante.

警告

电源 • 该设备只能使用产品上标明的电源。设备必须使用有地线的供电系统供电。第三条线（地线）是安全设施，不能不用或跳过。

拔掉电源 • 为安全地从设备拔掉电源，请拔掉所有设备后或桌面电源的电源线，或任何接到市电系统的电源线。

电源线保护 • 妥善布线，避免被踩踏，或重物挤压。

维护 • 所有维修必须由认证的维修人员进行。设备内部没有用户可以更换的零件。为避免出现触电危险不要自己试图打开设备盖子维修该设备。

通风孔 • 有些设备机壳上有通风槽或孔，它们是用来防止机内敏感元件过热。不要用任何东西挡住通风孔。

锂电池 • 不正确的更换电池会有爆炸的危险。必须使用与厂家推荐的相同或相近型号的电池。按照生产厂家的建议处理废弃电池。

FCC Class A Notice

NOTE This equipment has been tested and found to comply with the limits for a Class A digital device, pursuant to part 15 of the FCC Rules. These limits are designed to provide reasonable protection against harmful interference when the equipment is operated in a commercial environment. This equipment generates, uses and can radiate radio frequency energy and, if not installed and used in accordance with the instruction manual, may cause harmful interference to radio communications. Operation of this equipment in a residential area is likely to cause harmful interference, in which case the user will be required to correct the interference at his own expense.

NOTE This unit was tested with shielded cables on the peripheral devices. Shielded cables must be used with the unit to ensure compliance.

This device complies with Part 15 of the FCC Rules. Operation is subject to the following two conditions: (1) this device may not cause harmful interference, and (2) this device must accept any interference received, including interference that may cause undesired operation.

Quick Start — MAV Series AV Matrix Switchers





Installation

Step 1 — Mount

If desired, mount the switcher in a rack with the supplied rack ears or mount the switcher under a desk using an Extron MBU 149 1U Enclosure Under-desk mount kit, part #70-222-01.



Step 2 — Inputs

As applicable to your switcher, connect:

- a** Up to 4 or 8 S-video inputs to the input connectors. 
- or — Up to 4 or 8 composite video inputs to the input connectors. 
- b** Up to 4 or 8 unbalanced stereo audio inputs to the input RCA connectors. 
- or — Up to 4 or 8 balanced or unbalanced stereo audio inputs to the input captive screw connectors. 

Step 3 — Outputs

As applicable to your switcher, connect:

- a** Up to 4 or 8 S-video or composite video devices to the output connectors. 
- b** Up to 4 or 8 unbalanced stereo audio devices to the output RCA connectors. 
- or — Up to 4 or 8 balanced or unbalanced stereo audio devices to the output captive screw connectors. 

CAUTION Connect the sleeve to ground. Connecting the sleeve to a negative (-) terminal will damage the audio output circuits.

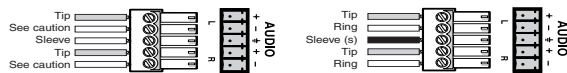

Unbalanced Output

Balanced Output

Step 4 — RS-232 Connections

If desired, connect a control system or a computer to the RS-232 port. See the table below

Step 5 — External Sync

If desired, feed a black burst (genlock) signal to the external sync connectors.



Pin	RS-232	Function
1	—	N/C
2	TX	Transmit data
3	RX	Receive data
4	—	N/C
5	Gnd	Signal ground
6	—	N/C
7	—	N/C
8	—	N/C
9	—	Hardwired IR

Step 6 — Connect power

Definitions

Tie — An input-to-output connection

Set of ties — An input **typed** to two or more outputs

Configuration — One or more **ties** or **sets of ties**

Current configuration — The currently active **configuration** (also called **configuration 0**)

Preset — A **configuration** that has been stored. One **preset** can be assigned to each input and output button. 16 presets are available via RS-232 control. When a **preset** is retrieved from memory, it becomes the **current configuration**.

Front Panel Features

Power/data/audio LED — Indicates power is applied. This LED also has two secondary functions:

Serial communication function — The Power/data/audio LED blinks off and on to indicate that an IR signal has been received.

Audio level function — In *Audio Setup* mode, the Power/data/audio LED lights when the selected input audio signal is at or above the reference level and is unlit when the signal is below the reference level. Adjust the gain until the LED blinks frequently. If the LED is almost always lit, blinking off only occasionally, the level is too high. If the LED is almost always off, blinking on (lit) only occasionally, the level is too low.

I/O button (audio/video switchers) selects video and audio, video, or audio for input selection.

Video and Audio LEDs (audio/video switchers) indicate whether video and audio, video, or audio is selected. The Audio LED blinks to indicate audio is broken away.

Input buttons select an input to tie to an output.

Input LEDs identify the input selected for the tie.

Output buttons select output(s) to tie to an input.

Output LEDs identify output(s) selected for the tie.

Enter button saves configuration changes.

Preset button selects *Save Preset* mode or *Recall Preset* mode, in which a configuration can be saved as a preset or recalled.

Audio Setup button and LED enable you to view and/or change the current audio level setting for each input. *Audio Setup is a secondary input function of the I/O button.*

Quick Start — MAV Series AV Matrix Switchers, cont'd

Down (▼) and Up (▲) buttons and LEDs decrease or increase the audio level for the selected input and indicate the decrease and increase. On 8-output switchers, ▼ and ▲ are secondary functions of the Output 7 and Output 8 buttons.

+dB/-dB LEDs indicate the polarity of the audio level setting (+dB = gain, -dB = attenuation). +dB and -dB are secondary functions of the Video and Audio LEDs.

Each audio input gain and attenuation indicator indicates a range of 6 dB when lit. (Output 1 LED off = 0 dB to 5 dB, Output 1 lit = 6 dB to 11 dB, Output 1 and 2 lit = 12 dB to 17 dB, Output 1 through 3 lit = 18 dB.) The level indicators are secondary functions of the Output 1 through Output 3 LEDs.

Operation

Powering on

Plug in the switcher to apply power. The switcher's self-test sequences the front panel LEDs.

Creating a tie

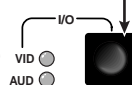
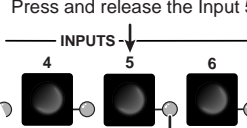
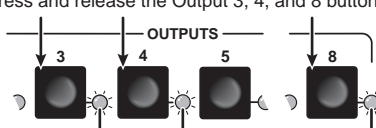
1. Press and release the I/O button to select or deselect video and/or audio as desired. The LEDs light when video and/or audio is selected. 
2. Press and release the desired input button*. 
3. Press and release the desired output button(s)*. 

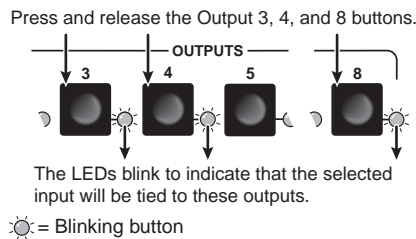

NOTE *You can cancel the entire set of ties at this point by waiting for the 5-second input/output button timeout to occur.

4. Press and release the Enter button. The selected input's and the selected outputs' LEDs light steadily for approximately 1 second to indicate the tie and then go out.

Saving or recalling a preset

1. **To Save a preset:** Press and hold the Preset button until the Preset LED starts blinking.

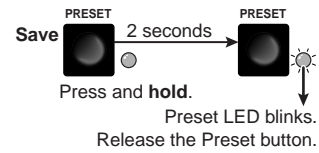

- To recall a preset:** Press and release the Preset button.



2. Press the desired input or output button.

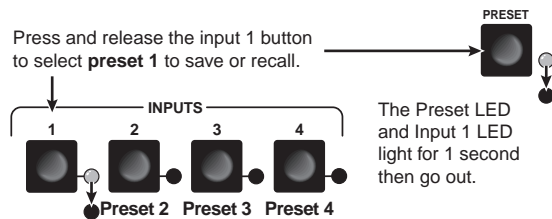

The selected input button and Preset button remain lit for 1 second to indicate the preset and then go out.

Viewing and adjusting the audio input gain

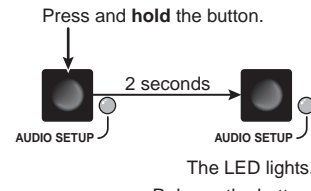
1. Apply audio signals to all inputs to be adjusted.
2. Press and hold the Audio Setup (I/O) button for 2 seconds until the Audio LED lights. 
3. Press an input button. See chapter 3 to read the displayed value.

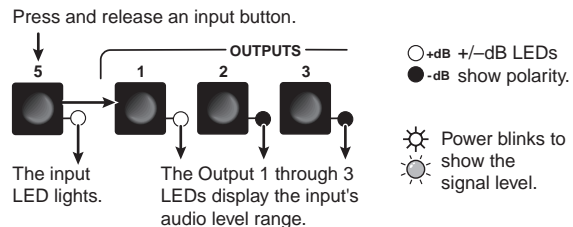

○ = lit, ● = unlit

4. Increase and decrease the audio input gain by pressing the ▲ and ▼ buttons until the audio level indicator (Power LED) blinks frequently.
5. For other inputs, repeat steps 3 and 4.
6. Press and release the Audio Setup button to exit.

Table of Contents

Chapter 1 • Introduction	1-1
About the Switchers	1-2
Features	1-3
Video features	1-3
Audio features	1-4
Common features	1-4
Chapter 2 • Installation	2-1
Mounting the Switcher	2-2
Tabletop use	2-2
Rack mounting the switcher	2-2
UL requirements	2-2
Mounting instructions	2-2
Furniture mounting the switcher	2-3
Cabling and Rear Panel Views	2-4
Video input and output connections	2-4
Audio input and output connections (audio/video models)	2-5
Remote connection	2-6
External sync connection	2-7
Power connection	2-8
Chapter 3 • Operation	3-1
Front Panel Controls and Indicators	3-2
Definitions	3-3
Power/data/audio LED and infrared sensor	3-3
Input and output selection controls and indicators	3-4
Control buttons and LEDs	3-4
I/O selection and audio/video controls and indicators (audio/video switchers)	3-5
Operations	3-6
Powering up the switcher	3-6
Creating a set of ties	3-7
Example 1: Create a set of video and audio ties	3-8
Example 2: Add a video tie to a set of video and audio ties	3-9
Example 3: Remove a tie from a set of ties	3-11
Viewing the configuration	3-12
Example 4: View ties by selecting an input	3-13
Example 5: View ties by selecting outputs	3-14
Using presets	3-16
Example 6: Save a preset	3-17
Example 7: Recall a preset	3-18
Adjusting input audio gain and attenuation	3-19
Example 8: Adjust the input audio gain	3-21
Resetting audio gain — single input	3-23
Resetting audio gain — all inputs	3-24
Setting the output audio level	3-24

Table of Contents, cont'd

Front panel security lockout (<i>Executive mode</i>)	3-25
Clearing all ties and presets	3-25
Resetting the system to factory defaults (audio/video switchers)	3-26
Memory	3-26
Optimizing the Audio (Audio/Video Switchers)	3-27
Troubleshooting	3-27
Worksheets	3-28
Worksheet example 1: System equipment	3-28
Worksheet example 2: Daily configuration	3-29
Worksheet example 3: Test configuration	3-30
Configuration worksheet	3-31
Chapter 4 • Remote Operation	4-1
Simple Instruction Set Control	4-2
Host-to-switcher instructions	4-2
Switcher-initiated messages	4-3
Switcher error responses	4-4
Using the command/response table	4-4
Symbol definitions	4-4
Command/response table for SIS commands	4-5
Loading firmware using an SIS command	4-10
Matrix Switchers Control Program	4-12
Installing the software	4-12
Using the software	4-13
Overview	4-13
Updating the firmware	4-15
Windows buttons, drop boxes, and the trash can	4-18
Windows menus	4-19
File menu	4-19
Tools menu	4-19
Audio-input Configuration selection	4-20
Preferences menu	4-20
Master-Reset selection	4-21
Using Emulation mode	4-22
Using the help system	4-22

Appendix A • Specifications and Part Numbers	A-1
Specifications	A-2
Part Numbers	A-6
MAV Series AV switchers	A-6
Included parts	A-6
Replacement parts	A-6
Optional accessories	A-7
Cables	A-7
Bulk cable	A-7
Assorted connectors	A-8
Pre-cut cables	A-8

Table of Contents, cont'd

All trademarks mentioned in this manual are the properties of their respective owners.

68-777-01 **Rev. D**
10 07



MAV 44 / 48 / 84 / 88 Matrix Switchers

Chapter One

Introduction

About the Switchers

Features

Introduction

About the Switchers

The Extron MAV Series AV matrix switchers (figure 1-1) are a family of broadcast quality matrix switchers that distribute any composite video or S-video input with audio to any combination of outputs. The MAV Series switchers can route multiple input/output ties simultaneously. The MAV Series switchers have a wide array of input and output configurations, video formats, and audio connections. Depending on the model, the switchers route a combination of S-video or composite video with audio on captive screw or RCA connectors.

NOTE The MAV 88 matrix size has models without audio.

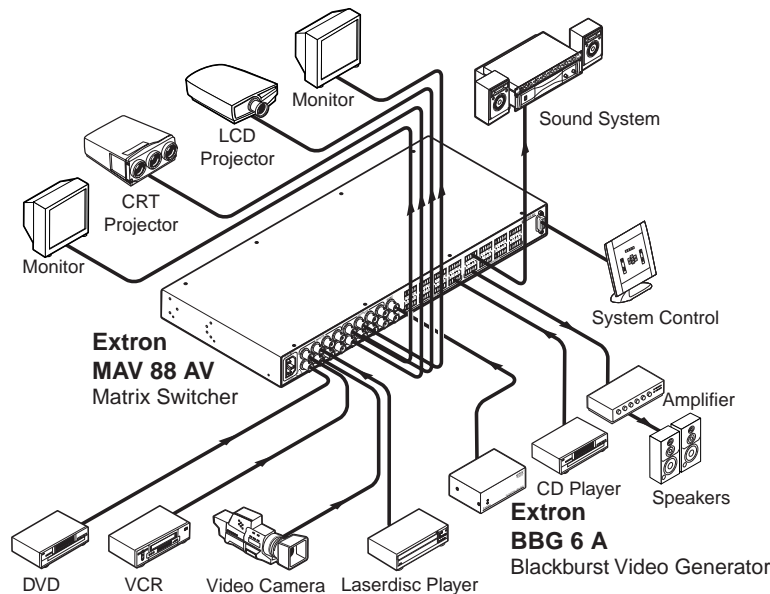

Figure 1-1 — Typical MAV 88 AV application

The table on the following page lists the models and the combinations of inputs and outputs available in the MAV Series switcher family.

The MAV switcher can be locally controlled on the front panel or remotely controlled via its rear panel RS-232 serial port or an optional IR 501 Small Matrix Infrared (IR) Remote Control (part # 70-336-01).

Model	Part #	Inputs				Outputs			
		Video	S-video	Captive screw audio	RCA audio	Video	S-video	Captive screw audio	RCA audio
MAV 44 SVA	60-553-22	No	4	4	No	No	4	4	No
MAV 44 SVA RCA	60-553-32	No	4	No	4	No	4	No	4
MAV 44 AV	60-553-21	4	No	4	No	4	No	4	No
MAV 44 AV RCA	60-553-31	4	No	No	4	4	No	No	4
MAV 48 SVA	60-605-22	No	4	4	No	No	8	8	No
MAV 48 SVA RCA	60-605-32	No	4	No	4	No	8	No	8
MAV 48 AV	60-605-21	4	No	4	No	8	No	8	No
MAV 48 AV RCA	60-605-31	4	No	No	4	8	No	No	8
MAV 84 SVA	60-554-22	No	8	8	No	No	4	4	No
MAV 84 SVA RCA	60-554-32	No	8	No	8	No	4	No	4
MAV 84 AV	60-554-21	8	No	8	No	4	No	4	No
MAV 84 AV RCA	60-554-31	8	No	No	8	4	No	No	4
MAV 88 SV	60-555-02	No	8	No	No	No	8	No	No
MAV 88 SVA	60-555-22	No	8	8	No	No	8	8	No
MAV 88 SVA RCA	60-555-32	No	8	No	8	No	8	No	8
MAV 88 V	60-555-01	8	No	No	No	8	No	No	No
MAV 88 AV	60-555-21	8	No	8	No	8	No	8	No
MAV 88 AV RCA	60-555-31	8	No	No	8	8	No	No	8

Features

Video features

S-video (SV) models — These switchers input and output NTSC 3.58, NTSC 4.43, PAL, or SECAM S-video (luminance [Y] and chrominance [C]) signals on 4-pin female mini DIN connectors.

Composite video (V) models — These switchers input and output NTSC 3.58, NTSC 4.43, PAL, and SECAM composite video signals on female BNC connectors.

Bandwidth (SV and V models) — Bandwidth is 150 MHz (-3 dB). This high bandwidth allows the switchers to switch all of the quad-standard video formats with no loss of signal quality.

Vertical interval switching — The switcher can use a black burst (genlock) signal to synchronize switching during the vertical interval. This ensures glitch-free switching among multiple timed sources.

Audio features

Captive screw audio connector (A) models — These switchers input and output balanced or unbalanced stereo audio signals, on 3.5 mm, 5-pole captive screw terminals.

RCA audio connector (A RCA) models — These switchers input and output unbalanced stereo audio signals on left and right RCA connectors.

Audio input gain/attenuation — You can set the level of audio gain or attenuation (+10 dB to -18 dB) via the RS-232 port or from the front panel. Individual input audio levels can be adjusted so there are no noticeable volume differences between sources and for the best headroom and signal-to-noise ratio. This function also eliminates the need for separate preamps or attenuators when used with professional (higher line level) and consumer (lower line level) audio equipment.

Audio output level switch — The audio level of each output can be set to either -10 dBV (consumer level) or +4 dBu (pro level) via RS-232 control only.

Audio follow — In audio/video switchers, audio can be switched with the corresponding video input. Audio follow switching can be done via front panel control, optional IR 501 control, or the RS-232 port.

Audio breakaway — In audio/video switchers, audio can be broken away from its corresponding video input signal. Audio breakaway switching can be done via front panel control, optional IR 501 control, or the RS-232 port.

Common features

Switching flexibility — Provides individually buffered, independent matrix switched outputs with audio follow and audio breakaway for audio versions.

- **Any input to any or all outputs**
- **Quick multiple tie** — Multiple inputs can be switched to multiple outputs simultaneously. This allows all displays (outputs) to change from source to source at the same time.

Operational flexibility — Operations such as input/output selection and setting of presets can be performed on the front panel, via the RS-232 port, or using the optional IR 501 small matrix universal remote control. The RS-232 port allows remote control via a PC or control system.

- **Front panel controller** — The MAV series front panel controller feature supports touch-of-a-button input and output selection, preset creation and selection, and audio gain and attenuation control.
- **RS-232 control** — The switcher's RS-232 port allows remote control via a PC or control system using Extron's Simple Instruction Set (SIS™) or the included Windows®-based control program.
- **Optional IR remote control** — The MAV switchers are remote controllable, using the optional small matrix IR remote control.

NOTE *The switcher's IR receiver is disabled by default and must be enabled to use the IR remote control. See the IR receiver enable SIS command in chapter 4, "Remote Operation" to enable the IR receiver.*

Upgradeable firmware — The firmware that controls the switcher's operation can be upgraded in the field via the RS-232 port, without taking the switcher out of service. Firmware upgrades are available for download on the Extron Web site, www.extron.com, and they can be installed using the Windows-based control program.

Global memory presets — 16 global memory presets are a time-saving feature that lets you set up and store input/output configurations in advance. You can then recall those configurations, when needed, with a few simple steps. On each model, there are as many presets available from the front panel as there are input and output buttons:

- MAV 44s have 8 presets available on the front panel.
- MAV 48s and MAV 84s have 12 presets available on the front panel.
- MAV 88s have 16 presets available on the front panel.

On smaller MAVs, presets that are not available from the front panel are still available under RS-232 or optional IR 501 control.

Rack mountable — With the included rack mounting kit, the switchers can be mounted in any conventional 19" wide rack.

Under-desk mountable — With an optional desk mounting kit, the switchers can be mounted under a desk, podium, or other furniture.

Front panel security lockout (executive mode) — If a MAV Series switcher is installed in an open area where operation by unauthorized personnel may be a problem, a security lock-out feature can be implemented. When the front panel is locked, a special button combination is required to unlock the front panel controller before it can be operated. Ties can still be viewed.

When the front panel is locked out, the switcher can still be operated via the RS-232 link.

Power supply — The matrix switchers' internal 100 VAC to 240 VAC, 50/60 Hz, 15 watts, auto-switchable power supply provides worldwide power compatibility.

Introduction, cont'd



MAV 44 / 48 / 84 / 88 Matrix Switchers

Chapter Two

Installation

Mounting the Switcher

Cabling and Rear Panel Views

Installation

Mounting the Switcher

NOTE *Keep the switcher out of bright light to prevent interference with the IR signals from the IR 501 remote control.*

Tabletop use

For tabletop use, affix a self-adhesive rubber foot to each corner of the bottom of the switcher.

Rack mounting the switcher

UL requirements

The following Underwriters Laboratories (UL) requirements pertain to the installation of the matrix switcher into a rack (figure 2-1).

1. **Elevated operating ambient temperature** — If installed in a closed or multi-unit rack assembly, the operating ambient temperature of the rack environment may be greater than room ambient. Therefore, consider installing the equipment in an environment compatible with the maximum ambient temperature (T_{ma}) specified by the manufacturer.
2. **Reduced air flow** — Installation of the equipment in a rack should be such that the amount of air flow required for safe operation of the equipment is not compromised.
3. **Mechanical loading** — Mounting of the equipment in the rack should be such that a hazardous condition is not achieved due to uneven mechanical loading.
4. **Circuit overloading** — Consideration should be given to the connection of the equipment to the supply circuit and the effect that overloading of the circuits might have on overcurrent protection and supply wiring. Appropriate consideration of equipment nameplate ratings should be used when addressing this concern.
5. **Reliable earthing (grounding)** — Reliable earthing of rack-mounted equipment should be maintained. Particular attention should be given to supply connections other than direct connections to the branch circuit (e.g. use of power strips).

Mounting instructions

All of the MAV Series AV switcher models are housed in rack-mountable, 1U-high, full-rack wide metal enclosures. The appropriate rack mounting kit is included with each switcher. Rack mount the switcher as follows:

1. If feet were previously installed on the bottom of the switcher, remove them.
2. Attach the rack mount brackets to the switcher with the eight #8 machine screws provided (figure 2-1).
3. Insert the switcher into the rack, aligning the holes in the mounting bracket with those of the rack.
4. Secure the switcher to the rack using the supplied machine screws.

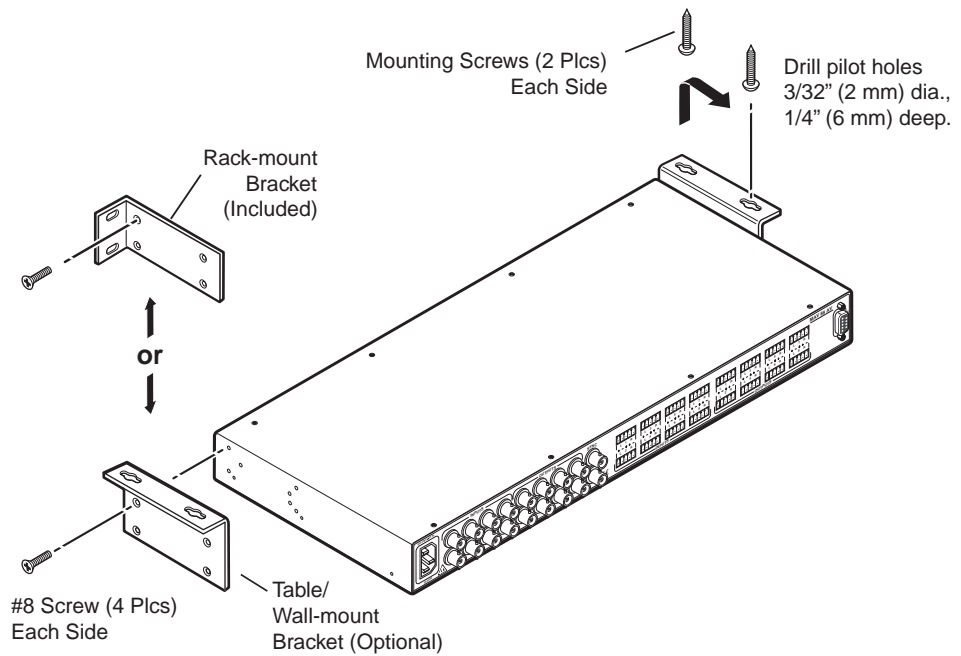

Figure 2-1 — Mounting the switcher

Furniture mounting the switcher

The MAV Series switcher models can be mounted under a table or other horizontal surface with an optional Extron under-desk mounting kit (part #70-222-01).

1. Secure the two table/wall mounting brackets to the switcher with the eight machine screws provided in the kit (figure 2-1).
2. Hold the switcher with attached brackets against the underside of the desk or other furniture. Mark the location of holes for screws on the underside of the desk.
3. Drill 1/4" (6.4 mm) deep, 3/32" (2 mm) diameter pilot holes in the table or desk at the marked screw locations from the underside/inside (concealed side) of the furniture, where the switcher will be located.
4. Insert the four wood screws into the pilot holes. Fasten each screw into the installation surface until just less than 1/4" of the screw head protrudes.
5. Align the installed screws with the slots in the mounting brackets, and place the switcher against the surface, with the screws through the bracket slots.
6. Slide the switcher slightly forward or back, then tighten all four screws to secure it in place.

Cabling and Rear Panel Views

All connectors are on the rear panel. The switcher can be connected to up to eight S-video, composite video, and/or stereo audio sources, depending on the model. The switcher can output to up to eight S-video, composite video, and/or audio devices.

Figure 2-2 shows a MAV 44 AV composite video and audio switcher. Figure 2-3 shows a MAV 88 SVA RCA S-video and audio switcher. All of the switchers are housed in the same 1U enclosures, but have more or fewer input connectors to accommodate the different configurations they provide. The two switchers shown have all of the connector types that are available in the MAV AV product family covered in this manual.

Some devices, such as VCRs, can be connected to both video and audio input and output connectors of the switcher. Others, such as tape players or CD players, can be connected only to the audio input connectors. An audio device and a separate video device can share an input, because the switcher is capable of switching video and audio separately (audio breakaway).

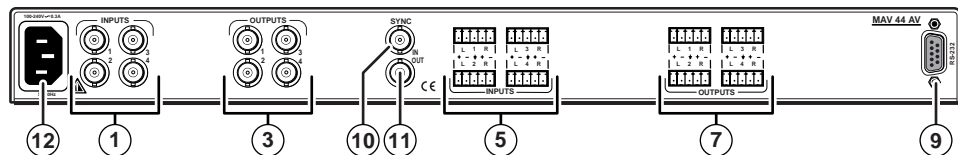

Figure 2-2 — MAV 44 AV composite video switcher with audio

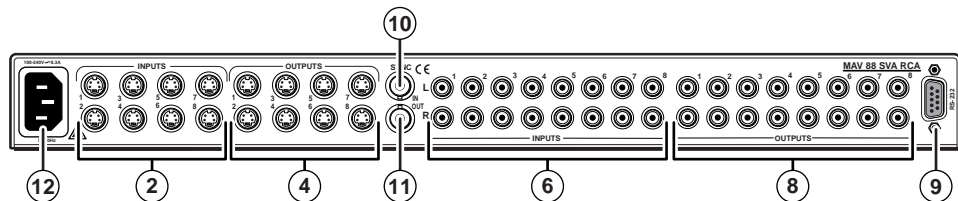

Figure 2-3 — MAV 88 SVA RCA S-video switcher with audio on RCA connectors

Video input and output connections

- ① **Composite video inputs (composite video [V] switchers only)** — For each input, connect a composite video source to one of these BNC connectors.
- ② **S-video inputs (S-video [SV] switchers only)** — For each input, connect an S-video source to one of these 4-pin mini DIN connectors.
- ③ **Composite video outputs (composite video [V] switcher models only)** — Connect a composite video display or other device to these BNC connectors for each composite video output.
- ④ **S-video output (S-video [SV] switchers only)** — Connect an S-video display or other device to this 4-pin mini DIN connector for each S-video output.

Audio input and output connections (audio/video models)

The audio level for each input can be individually set, via the front panel or RS-232, to ensure that the level on the output does not vary from input to input. See chapter 3, “Operation”, and chapter 4, “Remote Operation” for details.

By default, the audio follows the video switch. Audio breakaway, which is commanded via the front panel, under RS-232 control via the SIS or Windows-based control program, or optional IR 501 control, allows you to select from any one of the audio input sources. For details, see chapter 3, “Operation”, and chapter 4, “Remote Operation”, and refer to the *IR 501 Small Matrix IR Remote Control User’s Guide*.

- ⑤ **Balanced or unbalanced audio input connections (captive screw audio connector [A] models only)** — Each input has a 3.5 mm, 5-pole captive screw connector for balanced or unbalanced stereo audio input. Connectors are included with each MAV AV captive screw connector switcher, but you must supply the audio cable. See figure 2-4 to wire a connector for the appropriate input type and impedance level. High impedance is generally over 5 k ohms.

NOTE Figure 2-4 shows two methods of wiring the captive screw audio connectors for input and figure 2-6 shows two methods of wiring the connectors for output. A mono audio connector consists of the tip and sleeve. A stereo audio connector consists of the tip, ring, and sleeve. If you are wiring a captive screw connector from an existing unbalanced audio cable, the white insulated wire is typically the left channel (tip) and the red insulated wire is typically the right channel (sleeve). There is no reliable standard for existing balanced audio cables.

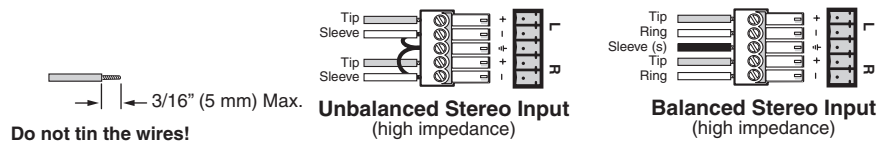

Figure 2-4 — Captive screw connector wiring for audio inputs

NOTE The length of exposed wires is critical. The ideal length is 3/16” (5 mm).

- If the stripped section of wire is longer than 3/16”, the exposed wires may touch, causing a short circuit between them.
- If the stripped section of wire is shorter than 3/16”, wires can be easily pulled out even if tightly fastened by the captive screws.

- ⑥ **RCA connector audio inputs (RCA audio connector [A RCA] models only)** — Each input has a pair (left and right) of RCA connectors for unbalanced stereo audio input (figure 2-5).

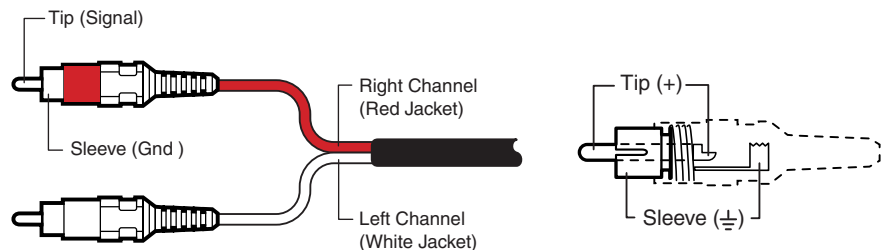

Figure 2-5 — RCA connector wiring

Installation, cont'd

- ⑦ **Balanced or unbalanced audio output connectors (captive screw audio connector [A] models only)** — These 3.5 mm, 5-pole captive screw connectors output the selected unamplified, line level audio. Connect audio devices, such as an audio amplifier or powered speakers to these connectors. See figure 2-6 to properly wire an output connector.

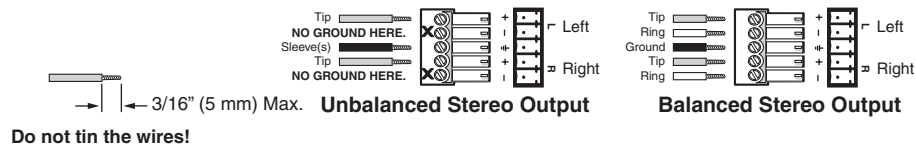

Figure 2-6 — Captive screw connector wiring for audio output

CAUTION Connect the sleeve to ground (Gnd). Connecting the sleeve to a negative (-) terminal will damage the audio output circuits.

NOTE The length of exposed wires is critical. The ideal length is 3/16" (5 mm).

- If the stripped section of wire is longer than 3/16", the exposed wires may touch, causing a short circuit between them.
 - If the stripped section of wire is shorter than 3/16", wires can be easily pulled out even if tightly fastened by the captive screws.
- ⑧ **RCA connector audio output (RCA connector audio [A RCA] models only)** — The switcher has a pair (left and right) of RCA connectors for each unbalanced stereo audio output (figure 2-5).

Remote connection

- ⑨ **RS-232 connector** — Connect a host device, such as a computer or control system, to the switcher via this 9-pin D connector (figure 2-7) for remote control of the switcher.

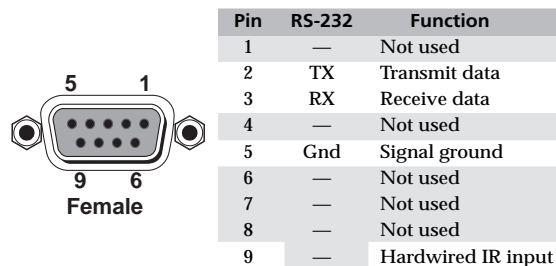

Figure 2-7 — RS-232 port pin assignment

NOTE The cable used to connect the RS-232 port to a computer or control system may need to be modified by removing pins or cutting wires. If you encounter problems while operating under RS-232 control (the switcher may hang up), pins 1, 4, 6, 7, 8, and 9 may need to be disconnected. Either cut the wire to pins 1, 4, and 6 through 9 in a hard-shelled connector or remove pins 1, 4, and 6 through 9 from a molded plug.

See chapter 4, "Remote Operation", for definitions of the SIS commands and details on how to install and use the control software.

Using the hardwired IR input on pin 9, you can use a control system with IR-learning capabilities to operate the switcher just as if you were using an IR 501 remote control. The control system must first “learn” the IR command from an IR 501, after which it sends the same commands to the MAV via pin 9.

External sync connection

The MAV switcher switches between inputs during the vertical interval period, resulting in glitch-free video switching. The MAV switcher can use an external signal to synchronize switching during the vertical interval. Without the external sync locking feature, switching between inputs can result in a brief rolling (sync loss) or a brief change in the picture size.

- ⑩ **Sync In connector** — Connect an external genlock signal to this BNC connector for genlocking the video signal in broadcast or other sync-critical applications.
- ⑪ **Sync Out connector** — Connect any downstream equipment that requires genlocking to this BNC connector to route the external sync signal throughout the system in broadcast or other sync-critical applications.

Figure 2-8 shows a basic external sync configuration.

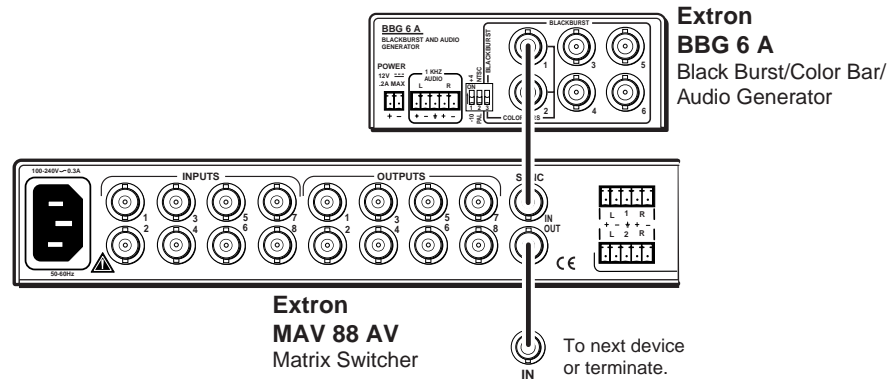

Figure 2-8 — Simple external sync connection example

Installation, cont'd

Figure 2-9 shows another configuration, in which the timing source passes through three video cameras and a video scan converter before connecting to the switcher. This type of video camera is capable of synchronizing with the external timing source for video editing applications.

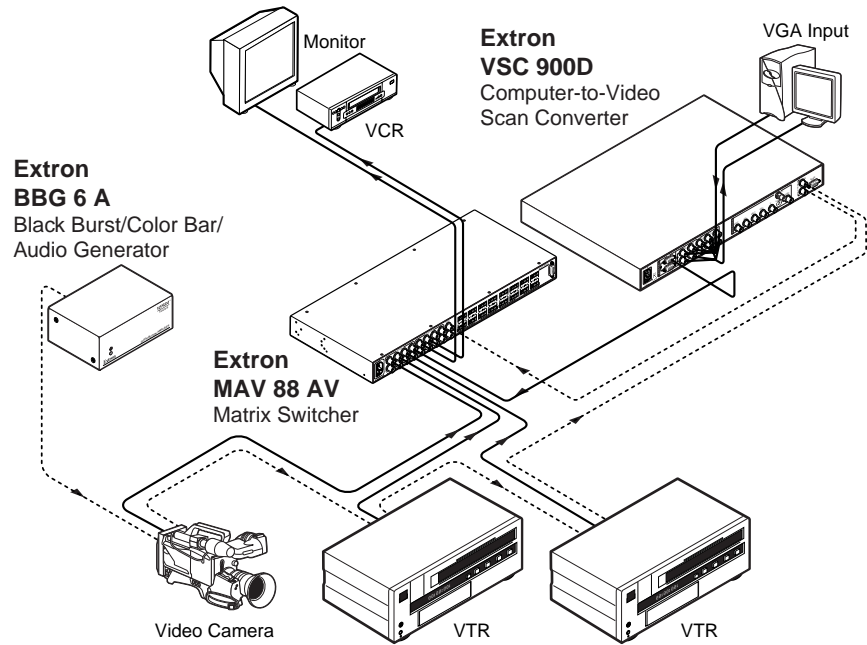

Figure 2-9 — Multiple device external sync connection example

If no external sync timing source is connected to the switcher, switching occurs immediately after a front panel or RS-232 switch command is received.

Power connection

- ⑫ **AC power connector** — Plug a standard IEC power cord into this connector to connect the switcher to a 100 VAC to 240 VAC, 50 or 60 Hz power source.



MAV 44 / 48 / 84 / 88 Matrix Switchers

3 Chapter Three

Operation

Front Panel Controls and Indicators

Operations

Optimizing the Audio (Audio/Video Switchers)

Troubleshooting

Worksheets

Operation

Front Panel Controls and Indicators

The number of input and output buttons and LEDs and other controls and LEDs that are present on each MAV Series AV matrix switcher vary with the number of inputs and outputs and whether the switcher has video only or both video and audio. Not every switcher has every control or indicator described in this chapter.

In the following descriptions, you will find the following terms:

- **Video-only switcher** — Switches S-video or composite video **only** and has **no** audio capabilities.
- **Audio/video switcher** — Switches either S-video or composite video **and** audio.

Figure 3-1 shows the front panel of an 8-input, 8-output video-only switcher. Figure 3-2 shows the front panel of a 4-input, 8-output video and audio switcher. These examples show all of the control and indicator combinations that you may encounter with your particular switcher.

Many of the buttons and LEDs on figure 3-2 have dual functions.

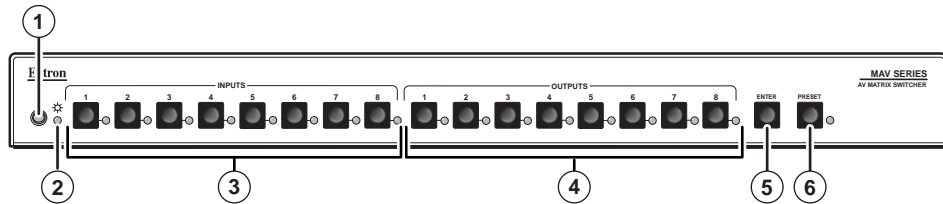

Figure 3-1 — MAV 88 V front panel

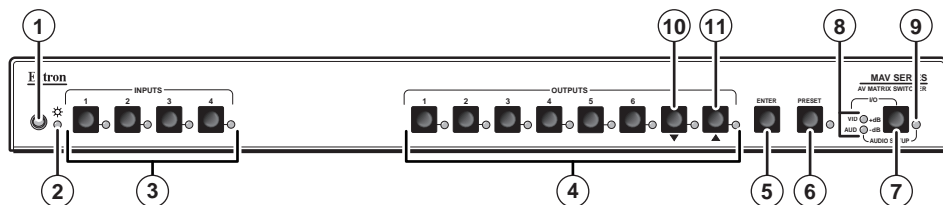

Figure 3-2 — MAV 48 SVA RCA front panel

Definitions

The following terms, which apply to Extron matrix switchers, are used throughout this manual:

Tie — An input-to-output connection

Set of ties — An input **typed** to two or more outputs. (An output can never be tied to more than one input.)

Configuration — Consists of one or more **ties** or one or more **sets of ties**

Current configuration — The **configuration** that is currently active in the switcher (also called **configuration 0**)

Global memory preset — A **configuration** that has been stored. Up to 16 **global memory presets** can be stored in memory. The input and output buttons are used to select the desired **preset** memory location to load or retrieve a **preset**. When a **preset** is retrieved from memory, it becomes the **current configuration**. On each model, there are as many presets available from the front panel as there are input and output buttons:

- MAV 44 models have 8 presets available on the front panel.
- MAV 48 and MAV 84 models have 12 presets available on the front panel.
- MAV 88 models have 16 presets available on the front panel.

On smaller MAV models, presets that are not available from the front panel are still available under RS-232 or optional IR 501 control.

Power/audio/data LED and infrared sensor

- ① **Infrared remote sensor** — This sensor receives infrared (IR) signals from the optional IR 501 small matrix universal remote control. The IR remote control must be pointed within 30 degrees of this sensor for best results.

Operation of the IR 501 remote control is described in the *IR 501 Small Matrix IR Remote Control User's Guide*.

NOTE *The switcher's IR receiver is disabled by default and must be enabled to use the IR remote control. See the IR receiver enable SIS command in chapter 4, "Remote Operation" to enable the IR receiver.*

NOTE *Keep the switcher out of bright light to prevent interference with the IR signals from the IR 501 remote control.*

- ② **Power/data/audio LED** —
- **When lit**, the Power LED indicates that power is applied to the matrix switcher.
 - **When blinking off and on**, the Power LED indicates that an IR signal has been received.
 - **In Audio Setup mode**, the Power LED also serves as an audio meter that is tied to output 1. The LED blinks frequently when the selected input's audio level has been adjusted to the -10 dBV internal reference level. (In *Audio Setup* mode, the selected input's audio is automatically tied to output 1.) See "Adjusting input audio gain and attenuation" on page 3-19 and "Optimizing the Audio (Audio/Video Switchers)" on page 3-27.

Input and output selection controls and indicators

NOTE *If the switcher has fewer than eight inputs or outputs, it has fewer input or output buttons and LEDs.*

- ③ **Input buttons and LEDs** — The input buttons and LEDs select and identify inputs.

Alternate preset selection function — The input buttons and LEDs also serve as preset selection buttons and indicators, allowing you to select presets to either save or recall. A more detailed explanation of the presets functions is included in “Using presets” beginning on page 3-16.

- ④ **Output buttons and LEDs** — The output buttons and LEDs select and identify outputs.

Alternate preset selection function — The output buttons and LEDs also serve as preset selection buttons and indicators, allowing you to select presets to either save or recall. A more detailed explanation of the presets functions is included in “Using presets” beginning on page 3-16.

Alternate audio indication function — On audio/video switchers, the Output 1 through Output 3 LEDs also serve as the input audio level indicators, each indicating a range of 6 dB when lit:

- Output 1 LED off = 0 dB to 5 dB
- Output 1 LED lit = 6 dB to 11 dB
- Output 1 and 2 LED lit = 12 dB to 17 dB
- Output 1 through Output 3 LEDs lit = 18 dB

See “Adjusting input audio gain and attenuation” on page 3-19.

Alternate audio adjustment function — On 8-output audio/video switchers, the Output 7 and Output 8 buttons and LEDs also serve as the Down (▼) and Up (▲) controls and negative (attenuation) and positive (gain) indicators. See ⑩ and ⑪.

Control buttons and LEDs

- ⑤ **Enter button** — The Enter button saves changes when you set up a new configuration. To create a simple configuration:

- Specify video, audio, or both (see controls [⑦] and [⑧]).
- Press the desired input button (③).
- Press the desired output button(s) (④).
- Press the Enter button.

- ⑥ **Preset button and LED** — The Preset button activates either *Save Preset* mode or *Recall Preset* mode. *Save Preset* mode saves a configuration as a preset. *Recall Preset* mode recalls and activates a previously-defined preset. The Preset button indicates *Save Preset* mode when it is blinking and *Recall Preset* mode when it lights steadily.

Alternate reset function — This button is also used to clear all ties and presets. See “Clearing all ties and presets” on page 3-25.

I/O selection and audio/video controls and indicators (audio/video switchers)

⑦ I/O and Audio Setup button —

- **Press and release** — Pressing the I/O button cycles through video and audio, video only, or audio only for input and output selection. See the Video and Audio LEDs (⑧) for the sequence.
- **Press and hold** — The I/O button also serves as the Audio Setup selection button. To enable the *Audio Setup* mode, press and **hold** the Audio Setup button for about 2 seconds until the Audio Setup LED (⑨) lights. In *Audio Setup* mode, you can view and/or change the current audio level setting for each input. See “Adjusting input audio gain and attenuation” on page 3-19.

Audio Setup mode times out after approximately 30 seconds of inactivity.

Alternate reset function — This button is also used to perform a system reset. See “Resetting the system to factory defaults (audio/video switchers)” on page 3-26.

⑧ Video/+dB LED and Audio/-dB LED —

- **I/O selection** — The Video and Audio LEDs indicate whether video and audio, video only, or audio only will be selected using the input buttons (③) and output buttons (④).

Pressing the I/O button advances through a cycle of video and/or audio selections as shown on figure 3-3.

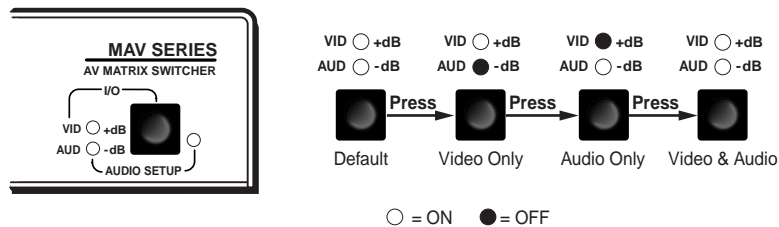

Figure 3-3 — Video and/or audio selection cycle

- **Audio Setup mode** — The -dB and +dB LEDs indicate the polarity of the audio level setting. See “Adjusting input audio gain and attenuation” on page 3-19. Both LEDs light to indicate unity gain (0 dB).

⑨ Audio Setup LED — The Audio Setup LED lights red to indicate that the switcher is in *Audio Setup* mode. See “Adjusting input audio gain and attenuation” on page 3-19.

Alternate IR error function — The Audio Setup LED also indicates errors when you use an IR 501 small matrix remote control. The LED lights for approximately 1 second when the switcher receives an unexpected or out-of-sequence IR command from the remote control. The switcher otherwise ignores the command.

Operation, cont'd

- ⑩ **Down (▼) button and LED** — The ▼ button decreases the audio gain for a selected input. Press and release the button to decrease the gain by 1 dB or press and **hold** the button to decrease the gain by 3 dB per second until the button is released or the lower limit is reached.

NOTE *On 4-output switchers, this button and LED stand alone.
On 8-output switchers, this button and LED are secondary functions of the Output 7 button and LED.*

The ▼ LED flashes once in *Audio Setup* mode to indicate each 1 dB decrease in the input audio gain. See “Adjusting input audio gain and attenuation” on page 3-19.

The ▼ LED lights steadily in *Audio Setup* mode to indicate that the adjustment has reached the maximum attenuation (-18 dB).

- ⑪ **Up (▲) button and LED** — The ▲ button increases the gain for a selected input. Press and release the button to increase the audio level by 1 dB or press and **hold** the button to increase the audio level by 3 dB per second until the button is released or the upper limit is reached.

NOTE *On 4-output switchers, this button and LED stand alone.
On 8-output switchers, this button and LED are secondary functions of the Output 8 button and LED.*

The ▲ LED flashes once in *Audio Setup* mode to indicate each 1 dB increase in the input audio gain. See “Adjusting input audio gain and attenuation” on page 3-19.

The ▲ LED lights steadily in *Audio Setup* mode to indicate that the adjustment has reached the maximum gain (+10 dB).

Operations

The following paragraphs detail the power-up process and then provide sample procedures for creating ties, sets of ties, and configurations; changing a configuration; viewing ties, sets of ties, and configurations; saving a preset; recalling a preset; viewing and adjusting the audio level, and selecting the front panel security lockout.

Powering up the switcher

1. Plug in the switcher. On all switcher models, power is automatically applied when the power cord is connected to an AC source. When AC power is applied, the switcher performs a self-test and initialization that blinks the front panel LEDs on and off from left to right. A successful power up self-test and initialization leaves the power LED on, the Video and Audio LEDs on (**audio/video models only**), and all other LEDs off.

The current configuration, all presets, and all input audio levels are saved in non-volatile memory within 5 seconds of a change or exiting *Audio Setup* mode. When power is applied, the most recent configuration is retrieved. The previous presets remain intact.

NOTE *Wait at least 5 seconds after changing any configuration, saving a preset, or exiting Audio Setup mode. Before 5 seconds have elapsed, changes that you have made **may not have been saved**.*

If an error occurs during the self-test, the switcher locks up and does not operate. If your switcher locks up on power-up, call the Extron S³ Sales & Technical Support Hotline.

-
2. Plug in all system components and turn on the input devices (such as DVD players, laserdisc players, VCRs, and DSS receivers) and the output devices.
 3. Set the input devices to output video using each device's own operating instructions.
 4. Create a tie (see below). The selected input image should appear at the selected output. If no image appears, see "Troubleshooting", on page 3-27.

Creating a set of ties

You can create a set of ties, changing the **current configuration**, by using the front panel buttons. Change the **current configuration** as follows:

1. On audio/video switchers, select to configure video, audio, or both by pressing the I/O button as necessary.
2. Select the desired input and output(s) by pressing the input and output buttons.
3. Press and release the Enter button.
4. Repeat steps 1 through 3 to create additional ties until the desired configuration is complete.

NOTE

- *Only one video input and one audio input can be tied to an output.*
- *If a tie is made between an input and an output, and the selected output was previously tied to another input, the older tie is broken in favor of the newer tie.*
- *Output LEDs light when an input is selected to indicate current ties. Press and release the associated output buttons to clear unwanted outputs.*
- *If, when you are configuring video and audio ties, the Audio LED blinks and the Video LED is on after you have selected an input or output, the LEDs indicate audio breakaway, meaning that the audio ties are not the same as the video ties for that input.*
- *If an input with no tie is selected, only that input's LED lights.*
- *As each output is selected, the associated output LED blinks to indicate a tentative tie until you press the Enter button or the 5-second timeout expires. LEDs for output(s) that were already tied to the input light steadily. Outputs that are already tied can be left on, along with new blinking selections, or toggled off by pressing the associated output button.*
- *If you inadvertently press the wrong input or output button, wait approximately 5 seconds. The input and output button selections time out and are abandoned.*

Operation, cont'd

Example 1: Create a set of video and audio ties

The following steps show an example in which input 5 is tied to outputs 3, 4, and 8. The example shows the front panel indications that result from your actions.

NOTE This example assumes that there are no ties in the current configuration.

1. **Audio/video switchers only** — Select video and audio for the tie (figure 3-4).

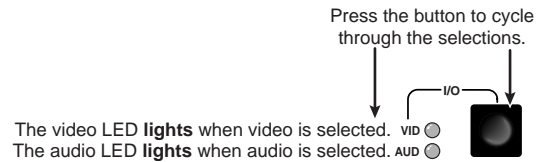

Figure 3-4 — Select video and audio

2. Press and release the Input 5 button (figure 3-5).

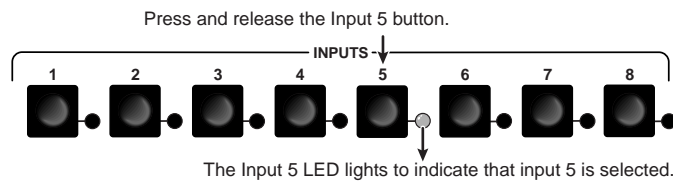

Figure 3-5 — Select an input

3. Press and release the Output 3, Output 4, and Output 8 buttons (figure 3-6).

NOTE The entire set of ties can be canceled at this point by waiting for the 5-second input/output button timeout to occur.

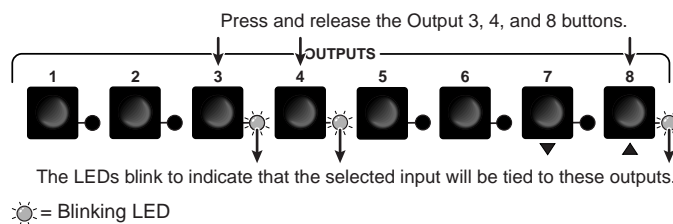

Figure 3-6 — Select the outputs

4. Press and release the Enter button (figure 3-7).

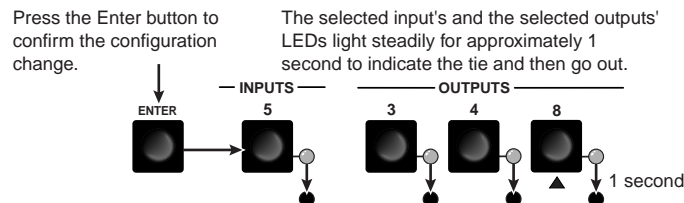

Figure 3-7 — Press the Enter button

The current configuration (figure 3-8) is now:

- Input 5 video and audio tied to output 3, output 4, and output 8

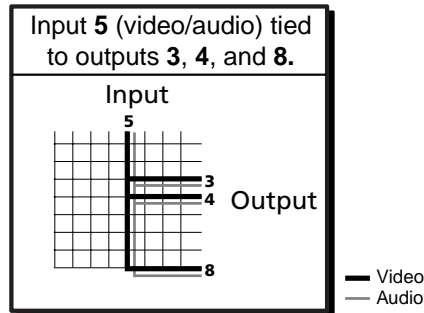

Figure 3-8 — Example 1, final configuration

Example 2: Add a video tie to a set of video and audio ties

The following steps show an example in which a new video tie is added to the current configuration. The example shows the front panel indications that result from your actions.

NOTE This example assumes that you have performed example 1.

1. **Audio/video switchers only** — Select video only for the tie (figure 3-9).

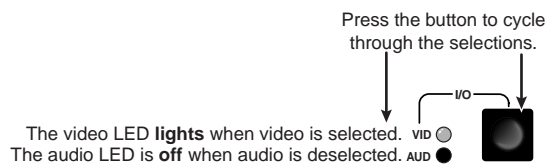

Figure 3-9 — Select video only

2. Press and release the Input 5 button (figure 3-10).

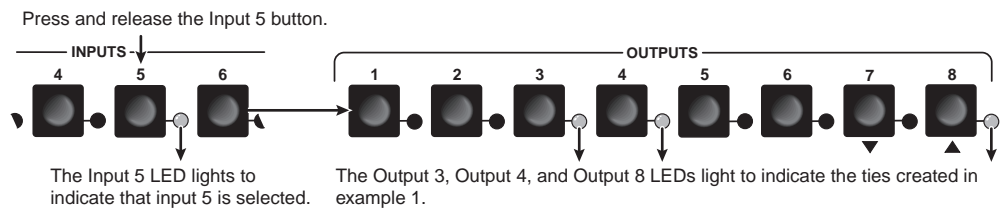

Figure 3-10 — Select an input

Operation, cont'd

- Press and release the Output 1 button (figure 3-11).

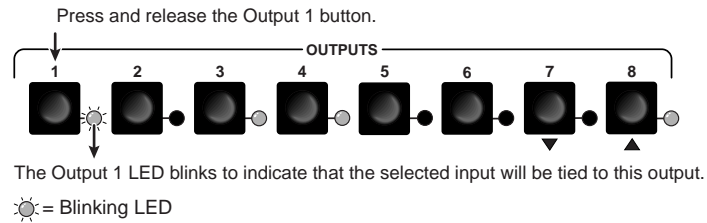

Figure 3-11 — Select the output

- Press and release the Enter button (figure 3-12).

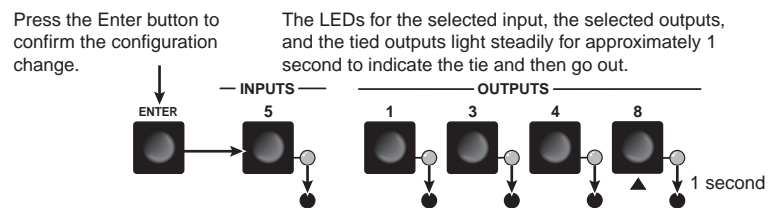

Figure 3-12 — Press the Enter button

The current configuration (figure 3-13) is now:

- Input 5 video tied to outputs 1, 3, 4, and 8
- (Audio/video switchers only) Input 5 audio tied to outputs 3, 4, and 8

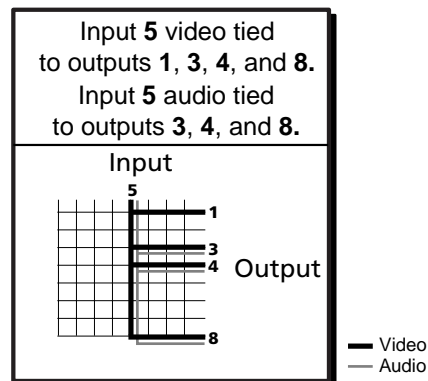

Figure 3-13 — Example 2, final configuration

Example 3: Remove a tie from a set of ties

NOTE This example shows two similar operations:

- Removing an audio tie from a set of ties on an audio/video switcher
- Removing a tie on a video-only switcher

The following steps show an example in which an existing tie is removed from the current configuration. The example shows the front panel indications that result from your actions.

NOTE This example assumes that you have performed example 1 and example 2.

1. **Audio/video switchers only** — Select audio only for the tie (figure 3-14).

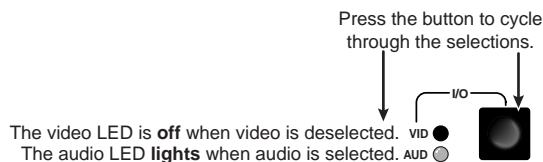

Figure 3-14 — Select audio only

2. Press and release the Input 5 button (figure 3-15).

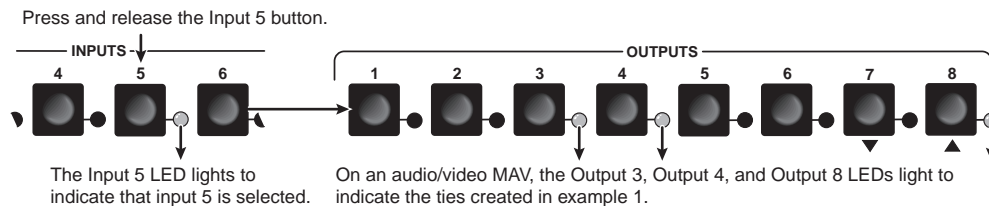

Figure 3-15 — Select an input

3. Press and release the Output 4 button (figure 3-16).

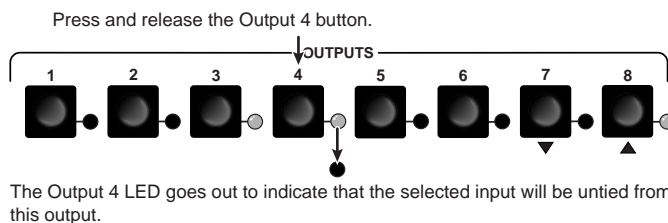

Figure 3-16 — Deselect the output

4. Press and release the Enter button (figure 3-17).

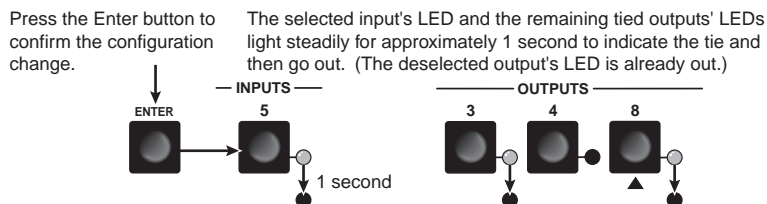

Figure 3-17 — Press the Enter button

Operation, cont'd

The current configuration (figure 3-18) is now:

- **Video** —
(**Video-only switcher**) — Input 5 tied to output 1, output 3, and output 8
(**Audio/video switcher**) — Input 5 video tied to output 1, output 3, output 4, and output 8
- **Audio** — (**Audio/video switcher**) Input 5 audio tied to output 3 and output 8

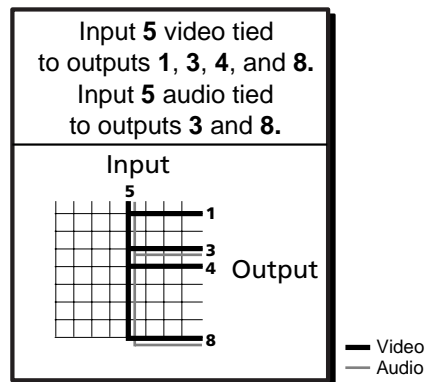

Figure 3-18 — Example 3, final configuration, audio switcher

Viewing the configuration

The current configuration (all active ties) can be viewed using the front panel buttons as follows:

1. Select video, audio, or both to view by pressing the I/O button.
2. Press and release an input or output button.
 - a. **Press and release an input button** — All of the buttons for outputs that are tied to the selected input light. If the Audio LED is flashing, it indicates that there are audio-only ties (audio breakaway).

NOTE Allow the 5-second timeout to deselect the input buttons before you select an output button. If an input button is still selected, the indications will not be as described and you may inadvertently establish potential ties that could be created by pressing the Enter button.

- b. **Press and release an output button** — The button for the tied input and all of the buttons for outputs that are also tied to the same input light. If the Audio LED is flashing, it indicates that there are audio-only ties (audio breakaway).

NOTE To see all ties of the current configuration, press and release each input or output button, one at a time, with the Video LED and the Audio LED lit.

3. After approximately 5 seconds, the LEDs for the input and tied outputs go out.

Example 4: View ties by selecting an input

The following steps show an example of viewing the video and audio, audio-only, and video-only ties in the current configuration by selecting an input. The example shows the front panel indications that result from your actions.

NOTE This example assumes that you have performed example 1, example 2, and example 3.

1. **Audio/video switchers only** — Select both video and audio for viewing (figure 3-19).

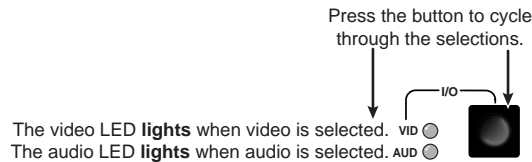

Figure 3-19 — Select video and audio

2. Press and release the Input 5 button (figure 3-20).

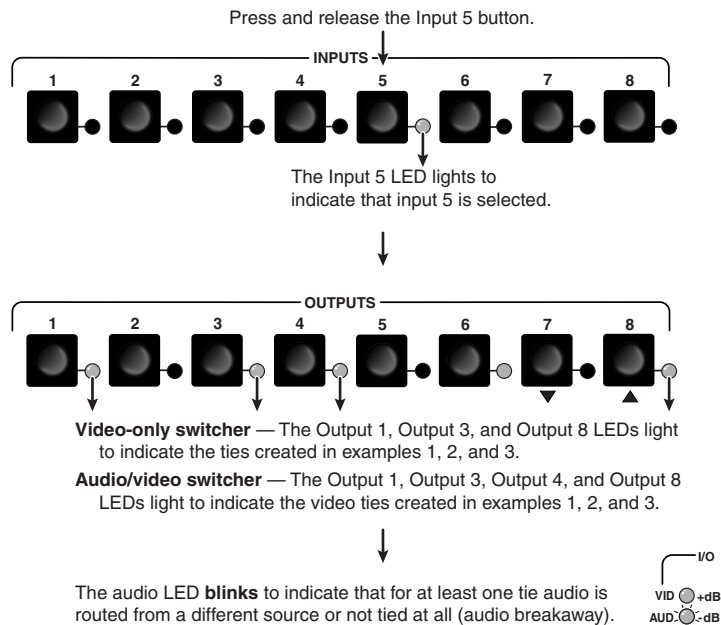

Figure 3-20 — Select an input

NOTE Steps 3 and 4 can be performed on an audio/video switcher only. If you have a video-only switcher, allow the 5-second input and output button timeout to deselect the input.

Operation, cont'd

- Press and release the I/O button (figure 3-21).

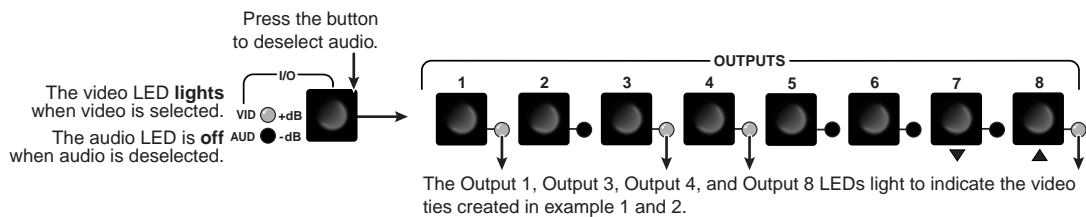

Figure 3-21 — Deselect audio to view video only

- Press and release the I/O button (figure 3-22).

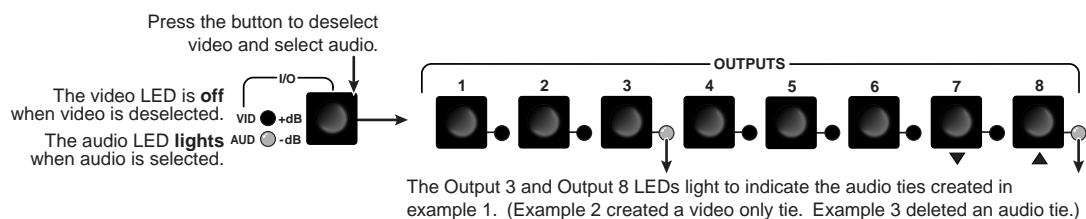

Figure 3-22 — Deselect video and select audio to view audio only

- Allow the 5-second input and output button timeout to deselect the input.

Example 5: View ties by selecting outputs

The following steps show an example of viewing the video and audio, audio-only, and video-only ties in the current configuration by selecting various outputs. The example shows the front panel indications that result from your actions.

NOTE This example assumes that you have performed example 1, example 2, and example 3.

- Audio/video switchers only** — Select both video and audio for viewing (figure 3-23).

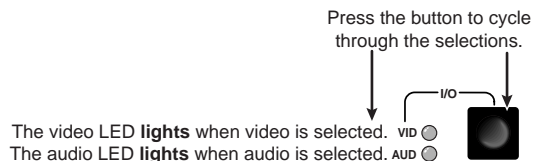

Figure 3-23 — Select video and audio

NOTE Ensure that no input button is selected before you select an output button. If an input button is selected, the indications will not be as described and you may inadvertently establish potential ties that could be created by pressing the Enter button.

If you do inadvertently establish a potential tie by selecting an input and output button, **do not press** the Enter button. Allow the 5-second timeout to deselect all input and output buttons.

2. Press and release the Output 3 button (figure 3-24).

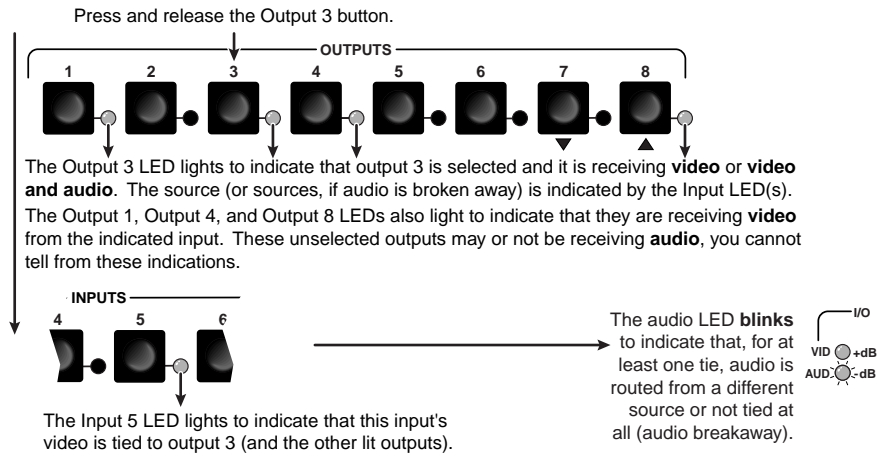

Figure 3-24 — Select an output

NOTE Steps 3 and 4 can be performed on an audio switcher only. If you have a video-only switcher, allow the 5-second input and output button timeout to deselect the input.

3. Press and release the I/O button (figure 3-25).

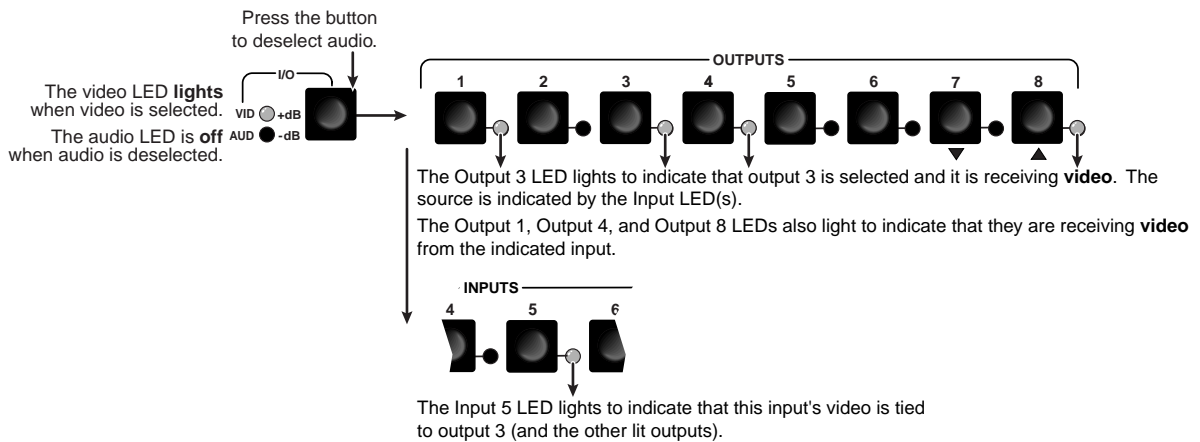

Figure 3-25 — Deselect audio to view video ties only

Operation, cont'd

4. Press and release the I/O button (figure 3-26).

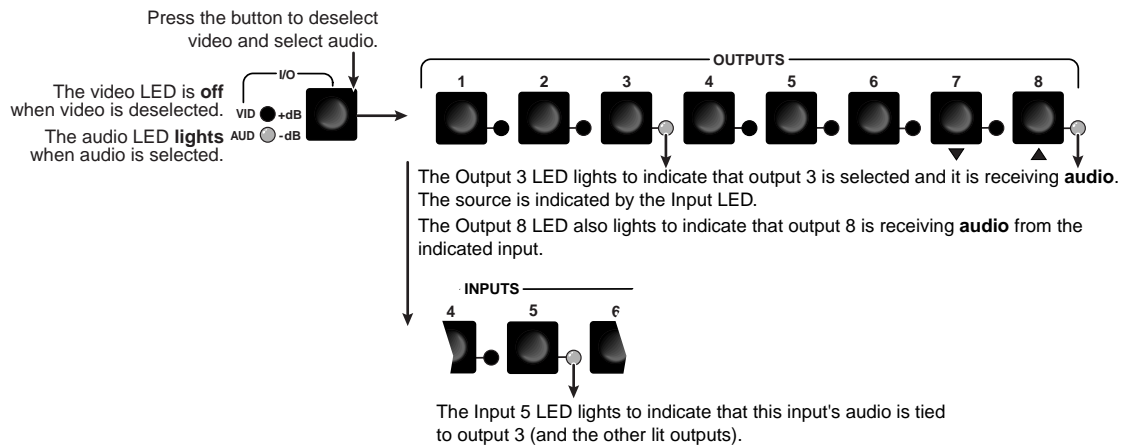

Figure 3-26 — Deselect video to view audio ties only

5. Allow the 5-second input and output button timeout to deselect the output.

Using presets

The current configuration (configuration 0) can be saved as a preset in any one of 16 preset memory addresses. Each switch has as many presets available from the front panel as it has input and output buttons. For example, MAV 44 has 8 presets (4 input buttons and 4 output buttons) available from the front panel and the MAV 88 has 16 (8 input buttons and 8 output buttons). Preset numbers above those available from the front panel are available under RS-232 or IR control only. See chapter 4, *Remote Operation*.

- NOTE**
- Only the audio and video ties are stored and recalled; audio gain settings are not saved, and they do not change when a preset is recalled.
 - Presets **cannot** be viewed from the front panel unless recalled as the current configuration. Presets **can** be viewed using Extron's Windows-based control program. See Chapter 4, "Remote Operation", for more details.
 - The current configuration and all presets are stored in non-volatile memory. When power is removed and restored, the current configuration is still active and all presets are retained.
 - When a preset is recalled, it replaces the current configuration, which is lost unless it is also stored as a preset. The recalled preset overwrites all of the current configuration ties in favor of the preset configuration ties.

Example 6: Save a preset

The following steps show an example in which the current configuration is saved as a preset. The example shows the front panel indications that result from your actions.

1. Press and **hold** the Preset button for approximately 2 seconds until the Preset LED begins blinking (figure 3-27).

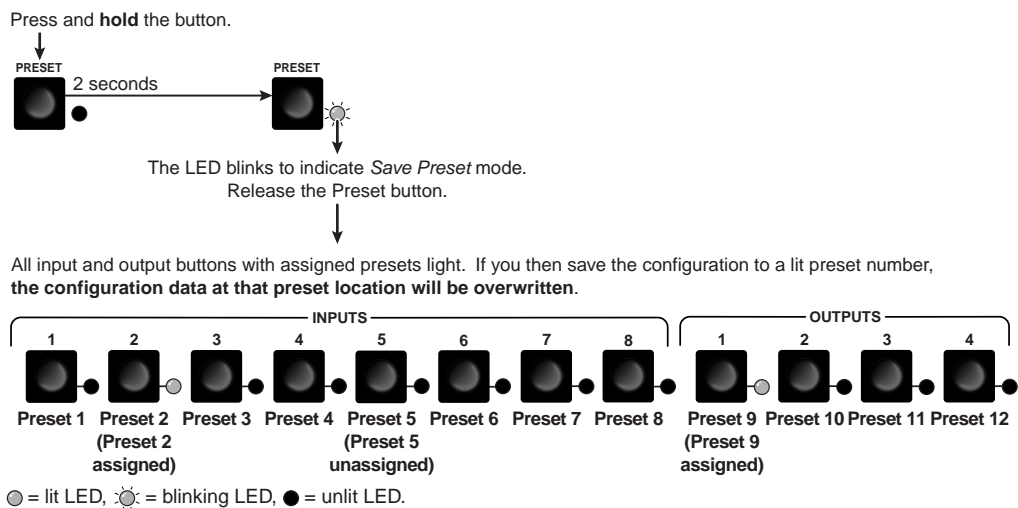

Figure 3-27 — Enter Save Preset mode, MAV 84

2. Press and release the Input 1 button (figure 3-28).

All LEDs but Input 1 and the Preset LED go out. The Input 1 LED and Preset LED remain lit for 1 second to indicate the saved preset number and then go out.

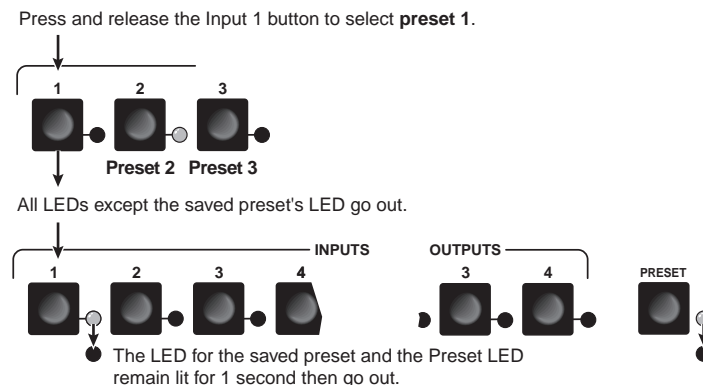

Figure 3-28 — Select the preset

Operation, cont'd

Example 7: Recall a preset

The following steps show an example in which a preset is recalled to become the current configuration. The example shows the front panel indications that result from your actions.

1. Press and release the Preset button (figure 3-29).

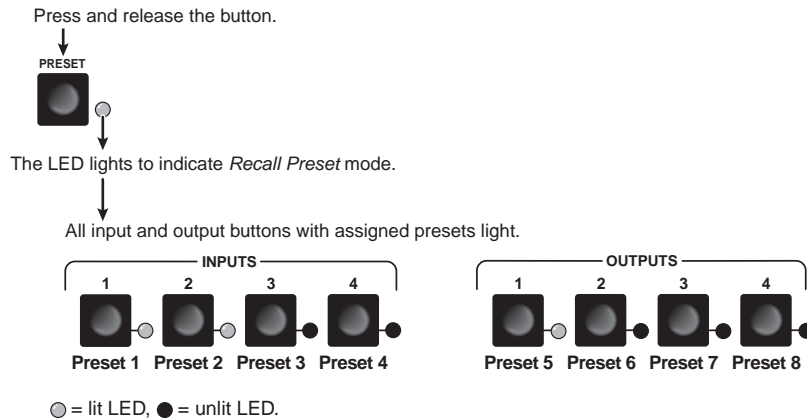

Figure 3-29 — Select Recall Preset mode, MAV 44

2. Press and release the Input 1 button (figure 3-30).

All LEDs but Input 1 and the Preset LED go out. The Input 1 LED and Preset LED remain lit for 1 second to indicate the recalled preset number and then go out.

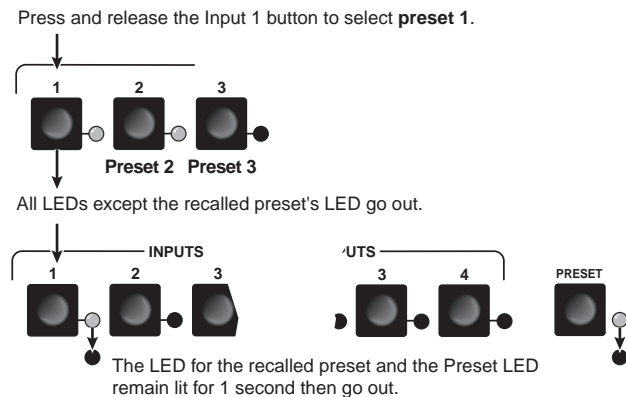

Figure 3-30 — Select the preset, MAV 48

Adjusting input audio gain and attenuation

Audio/video switchers have input audio gain and attenuation adjustments. In *Audio Setup* mode the audio gain or attenuation of each input can be adjusted through a range of -18 dB to $+10$ dB. This adjustment range ensures that there is no noticeable volume difference among sources. It also eliminates the need for separate preamps or attenuators when used with professional (higher line level) and consumer (lower line level) audio equipment (figure 3-31).

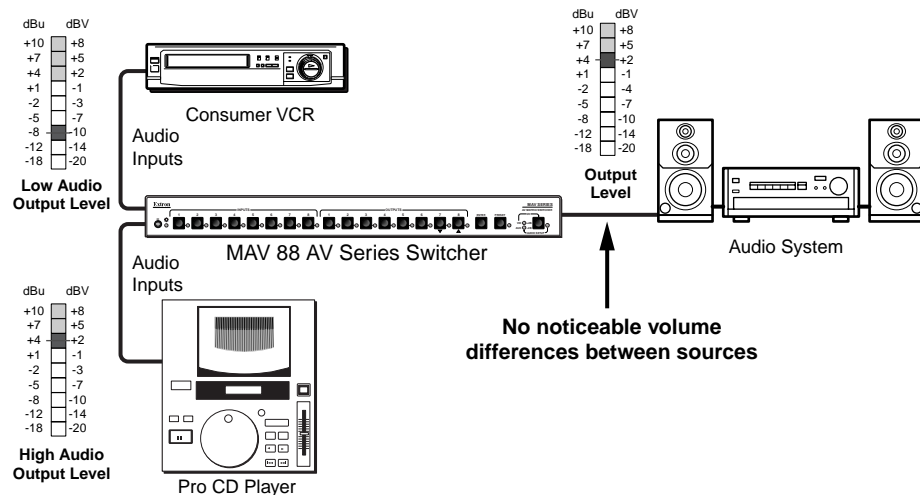

Figure 3-31 — Audio gain and attenuation

In *Audio Setup* mode, whichever input is selected for adjustment is automatically tied to output 1. You can connect a VU meter or an audio system to output 1 to measure or monitor the audio while you perform adjustments.

There are two ways to measure the audio level during audio setup:

- Monitor the input audio level indicator (Power LED) on the front panel.
- Connect a VU meter to output 1 and, if necessary, temporarily set the output 1 level to the consumer (-10 dBV) level (see the **Audio output level SIS** commands in chapter 4, "Remote Operation").

Operation, cont'd

The **input** audio gain or attenuation can be adjusted from the front panel or by using Extron's Windows-based control program.

1. Apply audio signals to all inputs to be adjusted.
2. Press and **hold** the Audio Setup (I/O) button until the Audio Setup LED lights. Release the Audio Setup button.
3. Press and release an input button to select an input. The selected input can be adjusted and is tied to output 1 for measurement or monitoring.
 - a. The Output 1 through Output 3 LEDs display the approximate audio gain or attenuation for the selected input. The +dB and -dB LEDs display the polarity (+ [gain] or - [attenuation]).
 - Each Output 1 through Output 3 LED indicates a range of 6 dB when lit:
 - Output 1 LED off = 0 dB to 5 dB
 - Output 1 LED lit = 6 dB to 11 dB
 - Output 1 and 2 LED lit = 12 dB to 17 dB
 - Output 1 through Output 3 LEDs lit = 18 dB
 - The +dB LED on indicates a positive (gain) level. The -dB LED on indicates a negative (attenuation) level. Both LEDs on indicate 0 dB. By noting these LEDs' displays and counting the number of 1 dB steps that you increase or decrease the audio level (step 4 and example 8, step 2a), you can determine the exact input gain or attenuation setting.
 - b. The Power LED blinks to indicate the adjusted audio level (compared to the internal level, -10 dBV):
 - When the LED is lit most of the time, blinking off only occasionally, the level is too high.
 - When the LED is off most of the time, blinking on (lit) only occasionally, the level is too low.
 - When the LED blinks frequently, the level is in the proper range.
 - c. The ▼ LED lights steadily when the adjustment is at the minimum level (maximum attenuation, -18 dB). The ▲ LED lights steadily when the adjustment is at the maximum gain (+10 dB).
4. Press and release the ▼ and ▲ buttons to increase and decrease the audio level by 1 dB or press and **hold** the buttons to increase or decrease the level by 3 dB per second. The ▼ or ▲ LEDs flash to indicate each 1 dB level change.

NOTE *Each time you press the ▼ or ▲ button, wait for the ▼ or ▲ LED to flash before pushing the button again. Pressing the button too rapidly may not increment or decrement the audio level.*

5. Press and release the Audio Setup button to save the level value in memory and to exit *Audio Setup* mode. The Audio Setup LED turns off.

NOTE

- *After approximately 30 seconds of front panel inactivity, the switcher saves the most recent input gain or attenuation levels and exits Audio Setup mode.*
- *There is one audio gain or attenuation setting per input. The setting is shared by the left and right audio inputs.*
- *The input audio gain or attenuation settings are stored in non-volatile memory. When power is removed and restored, the audio level settings are retained.*

Example 8: Adjust the input audio gain

The following steps show an example in which an input audio level is viewed and adjusted. The example shows the front panel indications that result from your actions.

1. Press and **hold** the Audio Setup (I/O) button for approximately 2 seconds (figure 3-32) until the Audio Setup LED lights.

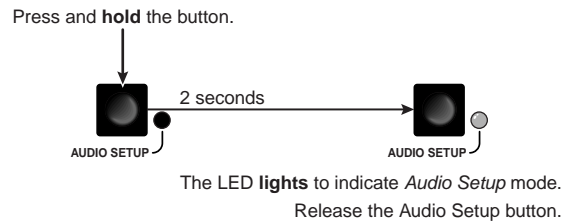

Figure 3-32 — Select Audio Setup mode

2. Press and release the Input 5 button (figure 3-33).

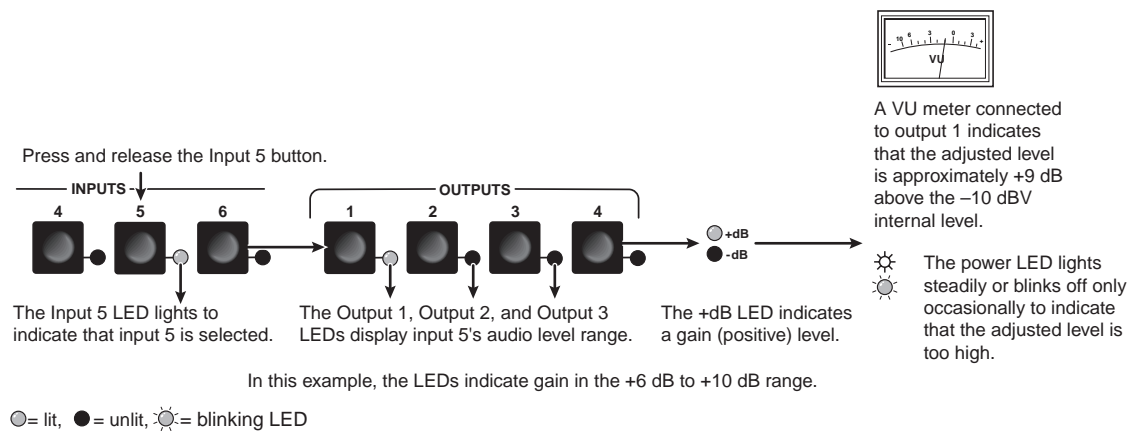

Figure 3-33 — Select an input

If the +dB and -dB LED are both lit they indicate an input gain of 0 dB. Otherwise, you can determine the exact gain or attenuation using the following procedure.

- a. **If one or more output LEDs are lit AND the +dB LED is lit**, press and release the ▼ button repeatedly until the highest-numbered lit output LED goes out. Count the button presses. **In example 8**, assume a value of +8 dB. It takes three presses of the ▼ button for the Output 1 LED to go out.

If one or more output LEDs are lit AND the -dB LED is lit, press and release the ▲ button repeatedly until the highest-numbered lit output LED goes out. Count the button presses.

If the +dB LED is lit and NO output LEDs are lit, press and release the ▼ button repeatedly until the +dB and -dB LED are both lit, indicating 0 dB. Count the button presses.

If the -dB LED is lit and NO output LEDs are lit, press and release the ▲ button repeatedly until the +dB and -dB LED are both lit, indicating 0 dB. Count the button presses.

Operation, cont'd

- b. Return to the original audio gain setting by pressing and releasing the ▼ or ▲ button (the opposite of the button you pressed in step a) the same number of steps you pressed the opposite arrow button in step 1. **In example 8**, this means pressing the ▲ button three times.
- c. Add the dB value indicated by the highest-numbered lit output LED (no output LEDs lit and both dB LEDs lit = 0 dB) and either of the following:
 - The number of button presses from 0 dB, or
 - The number of button presses from when the highest-numbered output LED lit. **In example 8:**

$$\begin{array}{r} \text{Output 1 LED:} \quad \mathbf{6 \text{ dB}} \\ + 2 \text{ presses:} \quad \mathbf{+2 \text{ dB}} \\ \hline \mathbf{8 \text{ dB}} \end{array}$$

- d. The lit +dB or -dB LED indicates the gain (+) or attenuation (-).
3. Press and release the ▼ button once to decrease the audio level (figure 3-34). The ▼ LED flashes each time the button is pressed.

Press and release the ▼ button several more times to continue to decrease the audio level (figure 3-34). Note the output LED, +dB LED, and -dB LED changes that occur each time the ▼ button is pressed and released.

Figure 3-34 shows the result of pressing the ▼ button a total of 9 times to change the value to -1 dB. Note that the +dB LED has turned off and that the -dB LED is on to indicate a negative level.

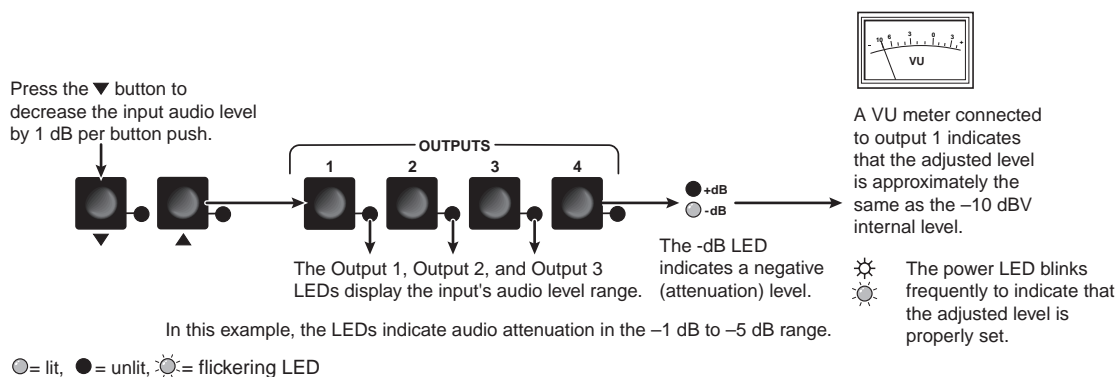

Figure 3-34 — Adjust the input audio level

NOTE *If another input button is pressed and released, the gain value for the current input is saved and the gain value for the newly selected input is displayed.*

4. Press and release the Audio Setup button (figure 3-35). All audio changes are saved.

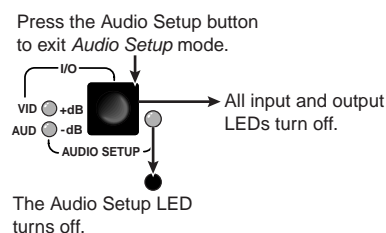

Figure 3-35 — Exit Audio Setup mode

Resetting audio gain — single input

Reset a specified input's audio gain or attenuation to the factory default (-12 dB for captive screw audio connector [A] models, 0 dB for RCA audio connector [A RCA] models) as follows:

1. Press and **hold** the Audio Setup (I/O) button for approximately 2 seconds until the Audio Setup LED lights (figure 3-36).

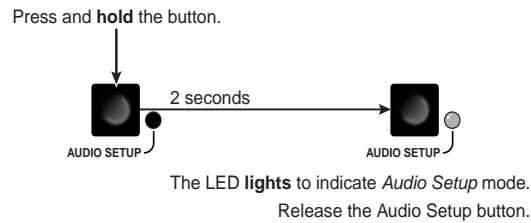

Figure 3-36 — Select Audio Setup mode

2. Press and release the Input 5 button (figure 3-37).

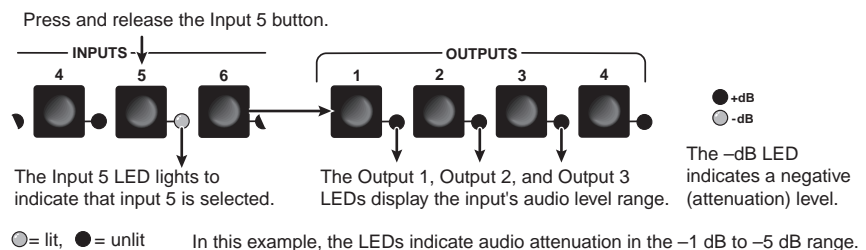

Figure 3-37 — Select an input

3. Press and release the ▼ and ▲ buttons simultaneously (figure 3-38).

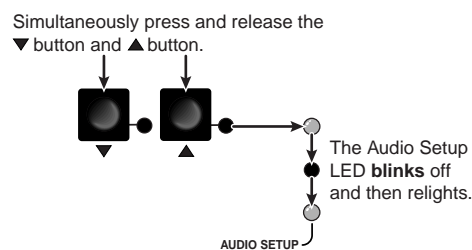

Figure 3-38 — Reset the selected input level

4. If desired, reset other inputs' audio levels by repeating steps 2 and 3.

NOTE After approximately 30 seconds of front panel inactivity, the switcher saves the most recent input gain or attenuation levels and exits Audio Setup mode.

Operation, cont'd

5. Press and release the Audio Setup button (figure 3-39). All audio changes are saved.

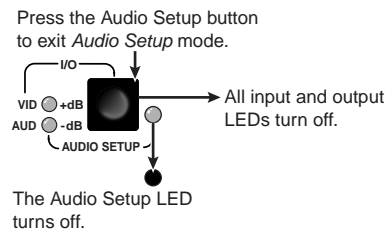

Figure 3-39 — Exit Audio Setup mode

Resetting audio gain — all inputs

Reset the input audio gain or attenuation to the factory default (-12 dB for captive screw audio connector [A] models, 0 dB for RCA audio connector [A RCA] models) for all inputs as follows:

1. Press and **hold** the Audio Setup (I/O) button for approximately 10 seconds (figure 3-40).

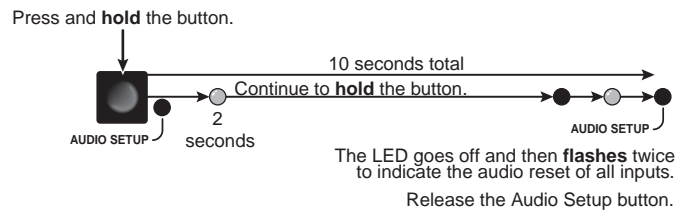

Figure 3-40 — Reset all input levels

Setting the output audio level

The output audio level can be set only via the RS-232 port, using either SIS commands or the Windows-based control program (see chapter 4, “Remote Operation”). The default settings are consumer level (-10 dBV) for RCA connector (A RCA) models and professional level (+4 dBu) for captive screw connector (A) models.

Front panel security lockout (*Executive mode*)

The MAV Series switchers have a front panel security lockout (*Executive mode*) feature that limits the operation of the switcher from the front panel and optional IR remote control. When the switcher is locked, the Enter button, I/O button (video only, audio/video, and audio only selection), and all of the front panel audio gain and attenuation functions are disabled. The front panel input and output buttons continue to allow ties to be viewed, but ties cannot be created.

The front panel security lockout also disables the IR remote sensor to lock out remote control functions.

Toggle the front panel lockout on and off by pressing and **holding** the Enter and Preset buttons for approximately 2 seconds (figure 3-41).

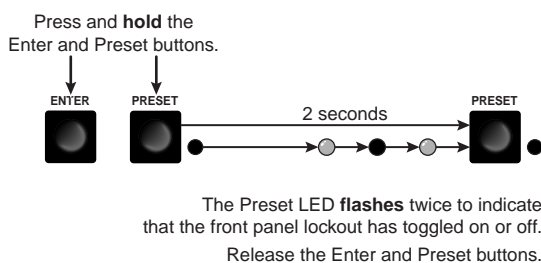

Figure 3-41 — Toggle front panel lockout on or off

Clearing all ties and presets

To clear all ties and saved presets, press and **hold** the Preset button on the front panel while applying AC power (figure 3-42). Continue to hold the Preset button until all LEDs light and then release the Preset button. The power up sequence completes:

- All LEDs turn off then turn on and off from left to right.
- The Video and Audio LEDs turn on (**audio/video models only**).
- All other LEDs remain off.

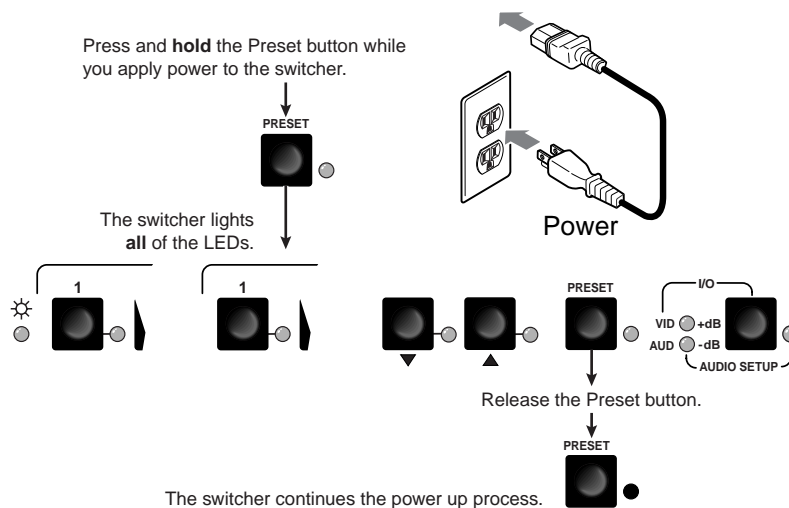

Figure 3-42 — Clear all ties and presets

Operation, cont'd

Resetting the system to factory defaults (audio/video switchers)

To reset an audio/video switcher to the factory default settings, press and **hold** the I/O button on the front panel while applying AC power (figure 3-43). Continue to hold the I/O button until all LEDs light and then release the I/O button. The power up sequence completes (all LEDs turn off then turn on and off from left to right, the Video and Audio LEDs turn on, and all other LEDs remain off). System reset:

- Clears all ties and presets
- Clears all video and audio mutes
- Sets the IR receiver to its default condition (disabled)
- Sets all input audio gain levels to their default values
 - -12 dB for captive screw audio connector (A) models
 - 0 dB for RCA audio connector (A RCA) models

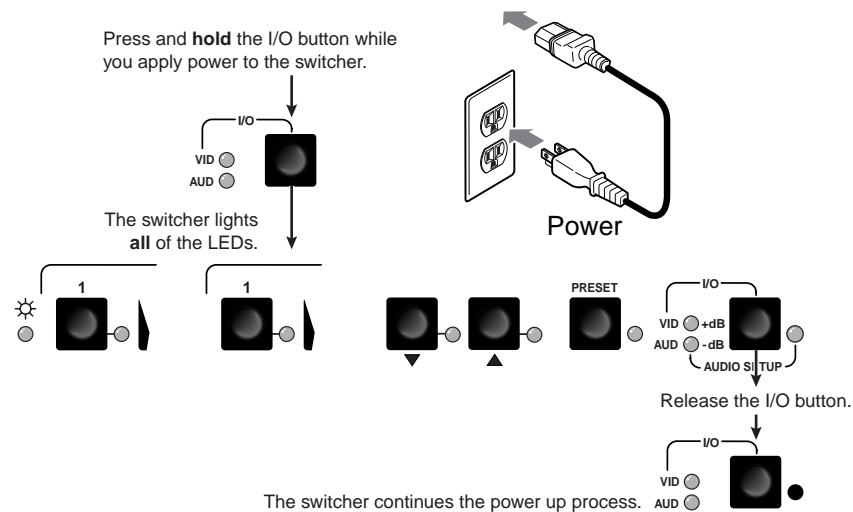

Figure 3-43 — System reset to factory defaults

Memory

The current configuration, all presets, and all input audio levels are saved in non-volatile memory within 5 seconds of a change or exiting *Audio Setup* mode. When power is applied, the last current configuration is retrieved. The previous presets remain intact.

NOTE Wait at least 5 seconds after changing any configuration, saving a preset, or exiting *Audio Setup* mode. Before 5 seconds have elapsed, changes that you have made **may not have been saved**.

Optimizing the Audio (Audio/Video Switchers)

Each individual input audio gain can be adjusted within a range of -18 dB to +10 dB to eliminate noticeable volume differences between sources and to achieve the best headroom and signal-to-noise ratio. Adjust the audio level as follows:

1. Connect audio sources to all desired inputs and connect the audio outputs to output devices such as audio players. See “Audio input and output connections (audio/video models)”, in chapter 2, “Installation”. For best results, wire all of the inputs and the outputs balanced when possible.
2. Power on the audio sources, the switcher, and the audio players.
3. Apply audio signals to all inputs to be optimized.
4. In *Audio Setup* mode (see “Adjusting input audio gain and attenuation”, on page 3-19) select among the inputs while observing the front panel Power LED. The LED blinks at a rate that corresponds to the highs and lows of the audio signal.
5. As necessary, adjust the audio gain of each input so that the Power LED blinks frequently for all selected inputs. If the LED is lit most of the time, the level is probably too high; if the LED rarely flashes, the level is too low.

As an alternative:

- If necessary, temporarily set the output 1 level to the consumer (-10 dBV) level (see the **Audio output level** SIS commands in chapter 4, “Remote Operation”).
- Measure the output 1 audio level (in *Audio Setup* mode, the selected input is tied to output 1) with test equipment, such as a VU meter, or listen to the output 1 audio with a critical ear.

Troubleshooting

This section gives recommendations on what to do if you have problems operating the MAV Series switcher.

1. Ensure that all devices are plugged in and powered on. The switcher is receiving power if the power LED is lit.
2. Ensure an active input is selected for output on the switcher.
3. Ensure that the proper signal format is supplied.
4. Check the cabling and make corrections as necessary.
5. Call the Extron S³ Sales & Technical Support Hotline if necessary.

Operation, cont'd

Worksheets

Rather than trying to remember the configuration for each preset, use worksheets to record this information. Make copies of the blank worksheet on page 3-31 and use one for each preset configuration. Cross out all unused or inactive inputs and outputs. If applicable, use different colors for video and audio.

Worksheet example 1: System equipment

Figure 3-44 shows a worksheet for a MAV 88 AV in a fictional organization with the system hardware annotated. Input 6 has no connection in this organization, so it has been crossed out on the worksheet.

Inputs include PCs (scan converted to composite video by an Extron USP 405 signal processor), an audio CD player, cameras, and an Extron VTG 300. Output devices include monitors, front and rear projectors, a stereo, and a VCR for recording presentations.

The VTG 300 video test generator connected to input 8 enables a video test pattern to be sent to one, several, or all output devices for problem isolation or adjustment purposes. An audio test tape or CD could be used in a similar manner to check out the audio components.

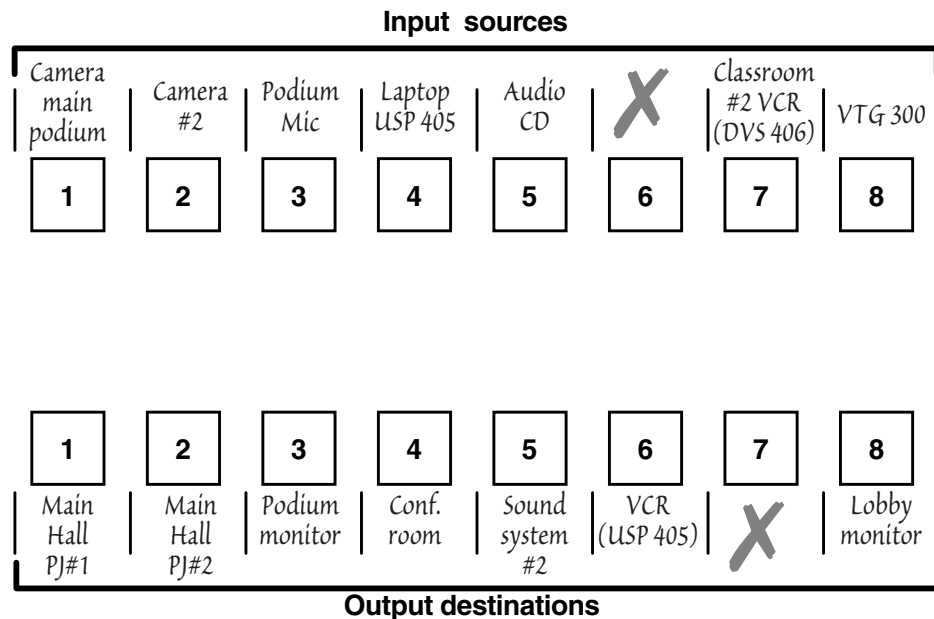

Preset # 1 Title: Worksheet Example Video: — Audio: --

Fill in the preset number, use colors or dashes, etc. to make connecting lines. Indicate if the configuration is for Video, Audio, or both.

Figure 3-44 — Worksheet example 1: System equipment

Worksheet example 2: Daily configuration

Figure 3-45 continues from worksheet example 1 by showing the video and audio ties that make up the configuration of preset 1. A solid ink line shows video ties and a dashed pencil line shows the audio ties.

In this example:

- The image of the presenter, from the main podium camera (input 1), is displayed:
 - In the main hall (output 1)
 - In the conference room (output 4) to the overflow crowd
 - In the lobby (output 8)
 - Tied to the VCR (output 6)
- The presenter has a presentation on her laptop computer (input 4) that is scan converted and displayed:
 - In the main hall (output 2)
 - Locally on the podium (output 3)
- The audio from her microphone (input 3) is played:
 - In the hall (output 1)
 - In the conference room (output 4)
 - Sent to the VCR
- Classical music from the CD player (input 5) is played:
 - In the background in the main hall on sound system #2 (output 5)
 - In the lobby (output 8)

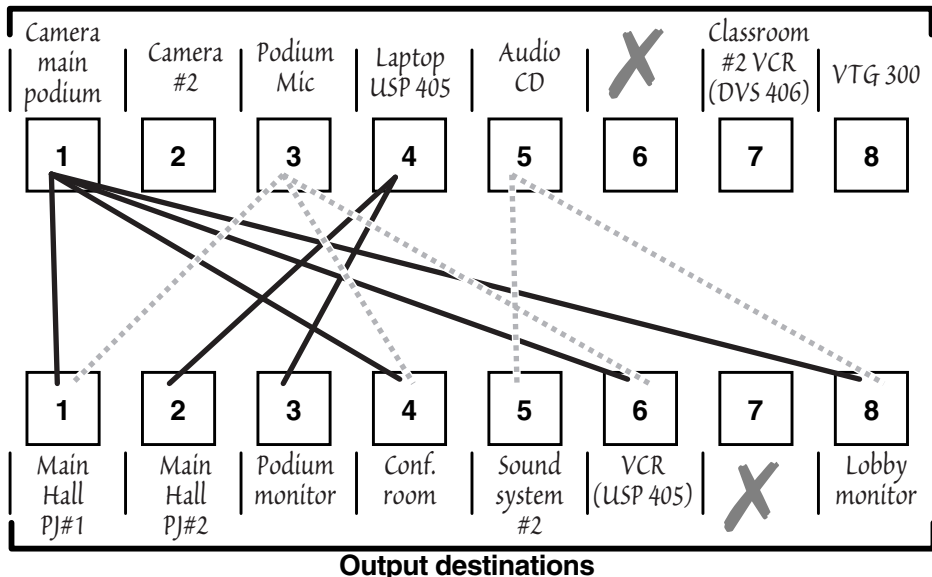

Preset # 1 Title: Worksheet Example Video: — Audio: --

Fill in the preset number, use colors or dashes, etc. to make connecting lines. Indicate if the configuration is for Video, Audio, or both.

Figure 3-45 — Worksheet example 2: Daily configuration

Operation, cont'd

Worksheet example 3: Test configuration

The A/V system in our fictional organization needs to be fine tuned on a regular basis. Figure 3-46 shows a typical test configuration, with an Extron video test generator (input 8) generating a test pattern to all monitors (outputs 1, 2, 3, 4, and 8). Sound checks are run from the CD player (input 5) to all audio systems (outputs 1, 2, 4, 5, and 8).

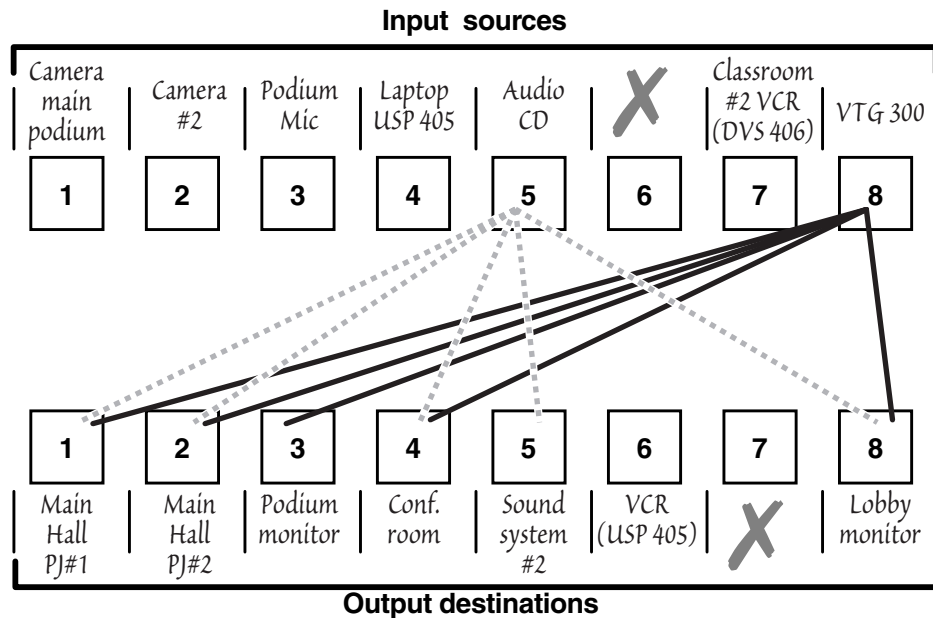

Preset # 1 Title: Worksheet Example Video: — Audio: --

Fill in the preset number, use colors or dashes, etc. to make connecting lines.

Indicate if the configuration is for Video, Audio, or both.

Figure 3-46 — Worksheet example 3: Test configuration

Configuration worksheet

Input sources

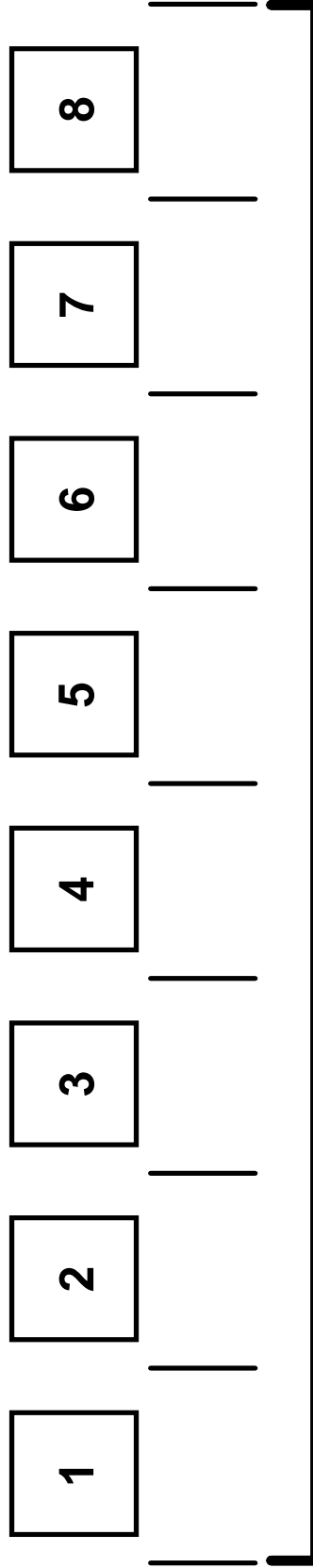
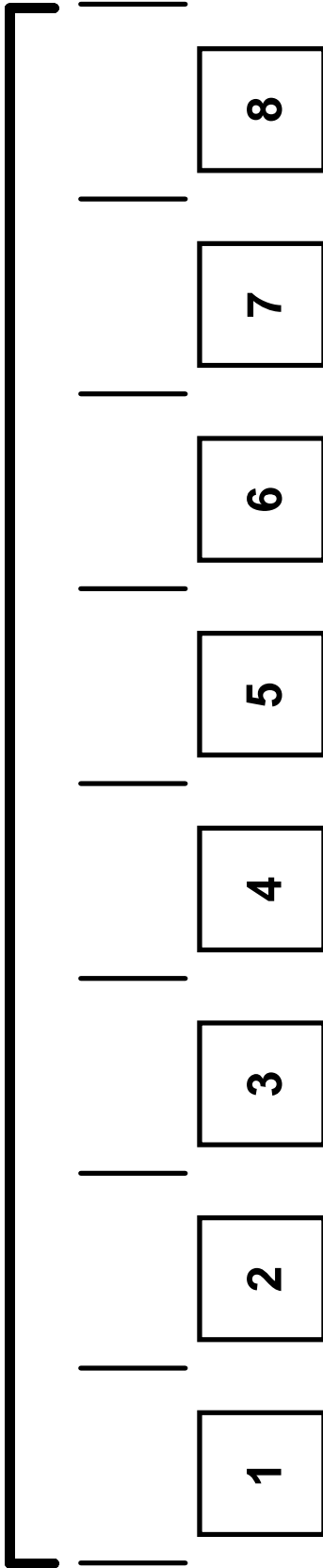

Output destinations

Preset # _____ Title: _____ Video: _____ Audio: _____
Fill in the preset number and use colors, or dashes, etc. to make connecting lines.
Indicate if the configuration is for Video, Audio, or both.

Operation, cont'd



MAV 44 / 48 / 84 / 88 Matrix Switchers

4 Chapter Four

Remote Operation

Simple Instruction Set Control

Matrix Switchers Control Program

Remote Operation

The MAV AV Series switchers can be remotely controlled via the switcher's rear panel RS-232 connector (figure 4-1) or using an optional infrared small matrix universal remote control (figure 4-2).

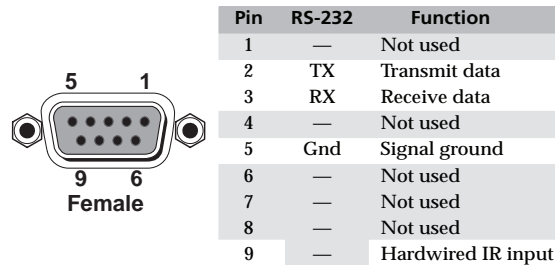

Figure 4-1 — Remote connector pinout

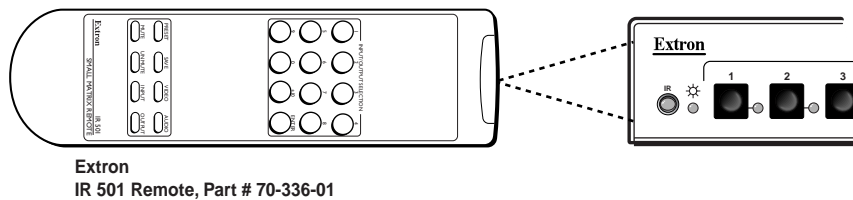

Figure 4-2 — Small matrix IR remote control

The RS-232 protocol is 9600 baud, 8-bit, 1 stop bit, no parity, and no flow control. RS-232 remote control devices can be either a host device, such as a computer or a control system.

NOTE When using communications software such as HyperTerminal to control the MAV switcher, verify that the terminal emulation is set to Auto Detect or ANSI and set flow control to None. Other settings may cause errors.

Two remote control methods are available: Extron's Simple Instruction Set and Extron's Windows-based control program.

Operation of the IR 501 remote control is described in the *IR 501 Small Matrix IR Remote Control User's Guide*.

NOTE The switcher's IR receiver is disabled by default and must be enabled to use the IR remote control. See the IR receiver enable SIS command on page 4-7 to enable the IR receiver.

Using the hardwired IR input on pin 9, you can use a control system with IR-learning capabilities to operate the switcher just as if you were using an IR 501 remote control. The control system must first "learn" the IR command from an IR 501, after which, it sends the same commands to the MAV via pin 9.

Simple Instruction Set Control

Host-to-Switcher instructions

The switcher accepts SIS (Simple Instruction Set) commands through the RS-232 port. SIS commands consist of one or more characters per command field. They do not require any special characters to begin or end the command character sequence. Each switcher response to an SIS command ends with a carriage return and a line feed (CR/LF = ↵), which signals the end of the response character string. A string is one or more characters.

Switcher-initiated messages

When a local event such as a front panel operation or an IR 501 command string occurs, the switcher responds by sending a message to the host. The switcher-initiated messages are listed below (underlined).

The switcher does not expect a response from the host, but, for example, the host program might request a new status.

(C) Copyright 2004, EXTRON ELECTRONICS “MAV *nn* series”, Vx.xx

The copyright message is initiated by the switcher when it is first powered on. Vx.xx is the firmware version number. “*nn*” is the matrix size (such as 88, eight inputs by eight outputs).

Qik

The switcher initiates the Qik message when a front panel or IR 501 tie creation has occurred.

Sprnn

The switcher initiates the Spr message when a memory preset has been saved from the front panel or under IR 501 control. “*nn*” is the preset number.

Rprnn

The switcher initiates the Rpr message when a memory preset has been recalled from the front panel or under IR 501 control. “*nn*” is the preset number.

Inn Audxx

The switcher initiates the Aud message when a front panel input audio level change has occurred. “*n*” is the input number and “*xx*” is the dB level.

Zpa

The switcher initiates the Zpa message when a reset of all audio input levels to 0 dB has been initiated from the front panel.

Exen

The switcher initiates the Exe message when the front panel security lockout (executive mode) is toggled on or off from the front panel. “*n*” is the executive mode status: 1 = on, 0 = off.

Vmtn*1

The switcher initiates the Vmt message when an IR 501 remote control output video mute command has occurred. “*n*” is the output number and “1” indicates the mute function is turned on (the output is muted).

Amt*1

The switcher initiates the Amt message when an IR 501 remote control output audio mute command has occurred. “*n*” is the output number and “1” indicates the mute function is turned on (the output is muted).

Mutn*1

The switcher initiates the Mut message when an IR 501 remote control output video and audio mute command has occurred. “*n*” is the output number and “1” indicates the mute function is turned on (the output is muted).

Zpz

The switcher initiates the Zpz message when an IR 501 remote control output unmute command has occurred. All video and audio outputs are unmuted.

Remote Operation, cont'd

Switcher error responses

When the switcher receives an SIS command and determines that it is valid, it performs the command and sends a response to the host device. If the switcher is unable to perform the command because the command is invalid or contains invalid parameters, the switcher returns an error response to the host. The error response codes are:

- E01 — Invalid input channel number (out of range)
- E10 — Invalid command
- E11 — Invalid preset number (out of range)
- E12 — Invalid output number (out of range)
- E13 — Invalid value (out of range)
- E14 — Invalid command for this configuration

Using the command/response table

The command/response table begins on page 4-5. Symbols used in the table represent variables in the command/response fields. Command and response examples are shown throughout the table. The ASCII to HEX conversion table at right is for use with the command/response table.

ASCII to HEX		Conversion Table		Esc 1B	CR 0D	LF 0A
Space 20	! 21	" 22	# 23	\$ 24	% 25	& 26
(28) 29	* 2A	+ 2B	, 2C	- 2D	. 2E
0 30	1 31	2 32	3 33	4 34	5 35	6 36
8 38	9 39	: 3A	; 3B	< 3C	= 3D	> 3E
@ 40	A 41	B 42	C 43	D 44	E 45	F 46
H 48	I 49	J 4A	K 4B	L 4C	M 4D	N 4E
P 50	Q 51	R 52	S 53	T 54	U 55	V 56
X 58	Y 59	Z 5A	[5B	\ 5C] 5D	^ 5E
` 60	a 61	b 62	c 63	d 64	e 65	f 66
h 68	i 69	j 6A	k 6B	l 6C	m 6D	n 6E
p 70	q 71	r 72	s 73	t 74	u 75	v 76
x 78	y 79	z 7A	{ 7B	7C	} 7D	~ 7E
						DEL 7F

NOTE With the exception of the audio input gain and attenuation commands, the SIS commands are **not** case sensitive.

Symbol definitions:

- ↵ = Carriage return/line feed
- ← = Carriage return (no line feed)
- = space

Esc = Escape key

X1 = Input number 1 through 4 (MAV 44, 48) or 1 through 8 (MAV 84, 88)

X2 = Input number (for tie) 0 (untie) – maximum number of inputs

X3 = Output number 1 through 4 (MAV 44, 84) or 1 through 8 (MAV 48, 88)

NOTE Input and output numbers in commands may be entered as either 1-digit, 2-digit, or 3-digit numbers. All input and output numbers are reported as 2-digit numbers in the response.

X4 = Numeric dB value –18 to +10 (29 steps [dB] of audio attenuation and gain)

X5 = Input audio gain 0 through 10 (1 dB/step)

X6 = Input audio attenuation 1 through 18 (1 dB/step)

X7 = Video/audio mute 0 = no mutes 2 = audio mute
1 = video mute 3 = video and audio mute

X8 = Front panel lock, mute 1 = on 0 = off

X9 = Output gain 0 = consumer level (–10 dBV) 1 = pro level (+4 dBu)

X10 = IR receiver 1 = disable (default) 0 = enable

X11 = Preset number 01 thru 16

X12 = Controller firmware version number to second decimal place

Command/response table for SIS commands

Command	ASCII Command (host to switcher)	Response (switcher to host)	Additional description
Create ties			
<p>NOTE 1. Commands can be made back-to-back, with no spaces. For example: 1*1!02*02%003*003\$4*4!.</p> <p>2. The quick multiple tie and tie input to all output commands activate all I/O switches simultaneously.</p> <p>3. The MAVs support 1-, 2-, and 3-digit numeric entries (1*1, 02*02, and 003*003).</p>			
Tie input $\boxed{x2}$ to output $\boxed{x3}$, video (V) and audio (A)	$\boxed{x2}*\boxed{x3}!$	Out $\boxed{x3}$ •In $\boxed{x2}$ •All↵	Tie input $\boxed{x2}$'s video and audio to output $\boxed{x3}$.
Example:	1*3!	Out3•In1•All↵	Tie input 1 video and audio to output 3.
Tie input $\boxed{x2}$ to output $\boxed{x3}$, video only	$\boxed{x2}*\boxed{x3}\%$	Out $\boxed{x3}$ •In $\boxed{x2}$ •Vid↵	Audio is broken away.
Example (see NOTE):	7*5%	Out5•In7•Vid↵	Tie input 7 video to output 5.
Tie input $\boxed{x2}$ to output $\boxed{x3}$, RGBHV	$\boxed{x2}*\boxed{x3}\&$	Out $\boxed{x3}$ •In $\boxed{x2}$ •RGB↵	Audio is broken away.
Example (see NOTE):	6*3&	Out3•In6•RGB↵	Tie input 6 RGB to output 3.
<p>NOTE The & tie command for RGB and the % tie command for video can be used interchangeably on the matrix switchers.</p>			
Tie input $\boxed{x2}$ to output $\boxed{x3}$, audio only	$\boxed{x2}*\boxed{x3}\$$	Out $\boxed{x3}$ •In $\boxed{x2}$ •Aud↵	Audio is broken away.
Example:	3*8\$	Out8•In3•Aud↵	Tie input 3 audio to output 8.
Quick multiple tie	$\text{Esc}+Q\boxed{x2}*\boxed{x3}!\dots\boxed{x2}*\boxed{x3}!\leftarrow Qik\leftarrow$		Make multiple ties.
Example:	$\text{Esc}+Q3*4!3*5%03*06\$ \leftarrow Qik\leftarrow$		Tie input 3 video and audio to output 4, tie input 3 video to output 5, and tie input 3 audio to output 6.
Tie video and audio input to all outputs	$\boxed{x2}!*!$	In $\boxed{x2}$ •All↵	
Example:	5*1!	In05•All↵	Tie input 5 video and audio to all outputs.
Tie video input to all outputs	$\boxed{x2}!*%$	In $\boxed{x2}$ •Vid↵	
Tie RGB input to all outputs	$\boxed{x2}!*&$	In $\boxed{x2}$ •RGB↵	
<p>NOTE The & tie all command for RGB and the % tie all command for video can be used interchangeably on the matrix switchers.</p>			
Tie audio input to all outputs	$\boxed{x2}!*\$$	In $\boxed{x2}$ •Aud↵	
Read ties			
Read video output tie	$\boxed{x3}\%$	$\boxed{x2}\leftarrow$	Video input $\boxed{x2}$ tied to output $\boxed{x3}$.
Read RGB output tie	$\boxed{x3}\&$	$\boxed{x2}\leftarrow$	RGB input $\boxed{x2}$ tied to output $\boxed{x3}$.
<p>NOTE The & read tie command for RGB and the % read tie command for video can be used interchangeably on the matrix switchers.</p>			
Read audio output tie	$\boxed{x3}\$$	$\boxed{x2}\leftarrow$	Audio input $\boxed{x2}$ tied to output $\boxed{x3}$.
Video mute commands			
Video mute	$\boxed{x3}*1B$	Vmt $\boxed{x3}*1\leftarrow$	Mute output $\boxed{x3}$ video (video off).
Video unmute	$\boxed{x3}*0B$	Vmt $\boxed{x3}*0\leftarrow$	Unmute output $\boxed{x3}$ video (video on).
Read video mute	$\boxed{x3}B$	$\boxed{x8}\leftarrow$	1= mute on, 0 = mute off.
Global RGB mute	1*B	Vmt1↵	Mute all video outputs.
Global RGB unmute	0*B	Vmt0↵	Unmute all video outputs.

Remote Operation, cont'd

Command/response table for SIS commands (cont'd)

Command	ASCII Command (host to switcher)	Response (switcher to host)	Additional description
IR Video mute commands			
NOTE An IR 501 user can mute video and/or audio with a string of IR commands that cannot be duplicated by a computer or control system sending SIS commands. The switcher sends the following responses:			
IR 501 video and audio mute	{none}	Mut[x3]*1 ↵	Output [x3]'s video and audio are muted.
IR 501 video mute	{none}	Vmt[x3]*1 ↵	Output [x3]'s video is muted.
IR 501 video and audio unmute	{none}	Zpz ↵	Output [x3]'s video and audio are unmuted.
Audio input gain and attenuation			
Set audio input gain to +dB value	[x1]*[x5]G	In[x1]•Aud[x4] ↵	
Example:	1*2G	In1•Aud+02 ↵	Set input 1 audio gain to +2 dB.
Set audio input attenuation to -dB value	[x1]*[x6]g	In[x1]•Aud[x4] ↵	
Increment gain up	[x1]+G	In[x1]•Aud[x4] ↵	
Example:	5+G	In5•Aud+03 ↵	Audio input 5 level incremented from +2 dB to +3 dB.
Decrement gain down	[x1]-G	In[x1]•Aud[x4] ↵	
Example:	7-G	In7•Aud-09 ↵	Audio input 7 level decremented from -8 dB to -9 dB.
Read input gain	[x1]G	[x4] ↵	
Example:	3G	-06 ↵	Audio input 3 level is -6 dB.
Audio output level			
Set audio output to consumer level (-10 dBV, default for RCA models)	[x3]*0*40#	Out[x3]•Lvl0 ↵	Set output [x3] level to the consumer level (-10 dBV).
Set audio output level to pro level (+4 dBu, default for captive screw models)	[x3]*1*40#	Out[x3]•Lvl1 ↵	Set output [x3] level to the pro level (+4 dBu).
Read output level	[x3]*40#	[x9] ↵	
Example:	3*40#	1 ↵	Output 3 audio level is pro level (+4 dBu).
Audio mute commands			
Audio mute	[x3]*1Z	Amt[x3]*1 ↵	Mute output [x3] video (audio off).
Audio unmute	[x3]*0Z	Amt[x3]*0 ↵	Unmute output [x3] video (audio on).
Read audio mute	[x3]Z	[x8] ↵	1= mute on, 0 = mute off.
Global audio mute	1*Z	Amt1 ↵	Mute all audio outputs.
Global audio unmute	0*Z	Amt0 ↵	Unmute all audio outputs.
NOTE An IR 501 user can mute audio and/or video with a string of IR commands that cannot be duplicated by a computer or control system sending SIS commands. The switcher sends the following responses:			
IR 501 audio and video mute	{none}	Mut[x3]*1 ↵	Output [x3]'s audio and video are muted.
IR 501 audio mute	{none}	Amt[x3]*1 ↵	Output [x3]'s audio is muted.
IR 501 audio and video unmute	{none}	Zpz ↵	Output [x3]'s audio and video are unmuted.

Remote Operation, cont'd

Command/response table for SIS commands (cont'd)

Command	ASCII Command (host to switcher)	Response (switcher to host)	Additional description
Resets			
Reset global presets	Esc ZG ←	Zpg ↵	Clear all global presets.
Reset individual global preset	Esc [X11]ZG ←	Zpg[X11] ↵	Clear global preset [X11].
Reset audio input levels	Esc ZA ←	Zpa ↵	Reset all input audio levels such that the output is -12 dB (captive screw audio connector (A) models) or 0 dB (RCA audio connector (A RCA) models).
Reset audio output levels	Esc ZV ←	Zpv ↵	Reset all output audio levels to pro level (captive screw audio connector (A) models) or consumer level (RCA audio connector (A RCA) models).
Reset all mutes	Esc ZZ ←	Zpz ↵	Unmute all outputs.
Reset whole switcher	Esc ZXXX ←	Zpx ↵	Clear all ties and global presets, and reset all audio gains to the factory default.
View ties, gain, mutes, and presets			
Read video output tie	[X3]%	[X2] ↵	Video input [X2] tied to output [X3].
Read RGB output tie	[X3]&	[X2] ↵	RGB input [X2] tied to output [X3].
Read audio output tie	[X3]\$	[X2] ↵	Audio input [X2] tied to output [X3].
Read input gain	[X1]G	[X4] ↵	
<i>Example:</i>	3G	-06 ↵	Audio input 3 level is -6 dB.
View all output mutes	Esc VM ←	[X7] ¹ [X7] ² [X7] ³ ... [X7] ⁿ ↵	Each position listed in the response is an output: left = output 1, right = the highest output number for this model.
<i>Example (MAV 84 AV):</i>	Esc VM ←	0132 ↵	Output 1 is unmuted, output 2 video is muted, output 3 video and audio are muted, and output 4 audio is muted. Outputs 5 through 8 are not present on this switcher.

Command/response table for SIS commands (cont'd)

Command	ASCII Command (host to switcher)	Response (switcher to host)	Additional description
View ties, gain, mutes, and presets (continued)			
View global preset configuration	<code>Esc</code> <code>[x1]</code> <code>VC</code> ←	<code>[x2]¹•[x2]²•[x2]³•...•[x2]ⁿ•Vid•[x2]¹•[x2]²•[x2]³•...•[x2]ⁿ•Aud</code> ↵	<i>n</i> is the highest output number for this model switcher. Show preset <code>[x1]</code> 's video and audio configuration. Show the video input tied to <i>n</i> sequential outputs and then the audio input tied to <i>n</i> sequential outputs.
<i>Response description:</i>		Video input # (I#) assigned to Output # (O#)1•I# assigned to O#2...I# assigned to O#8 • Vid • Audio I# assigned to O#1•I# assigned to O#2...I# assigned to O#8 • Aud ↵	
<i>Example (MAV 88 AV):</i>	<code>Esc</code> 4 <code>VC</code> ←	Input 5 video tied to output 2 No tied input Audio input 8 tied to output 5 Response = tied input: <code>6•5•6•8•3•3•1•0•Vid•8•1•1•1•8•8•8•8•Aud</code> ↵ Output: 1 2 3 4 5 6 7 8 1 2 3 4 5 6 7 8	
Each position shown in the response is an output: left = output 1, right = output 8. The number in each position is the input tied to that output. Global preset 4 makes the following ties:			
Video — Input 6 is tied to outputs 1 and 3; input 5 to output 2; input 8 to output 4; input 3 to outputs 5 and 6, and input 1 to output 7. No input is tied to output 8.			
Audio — Input 8 is tied to outputs 1 and outputs 5 through 8; input 1 to outputs 2 through 4.			
<i>Example (MAV 44 V):</i>	<code>Esc</code> 4 <code>VC</code> ←	Input 1 tied to output 2 Response = tied input: <code>1•1•0•2•Vid</code> ↵ Output: 1 1 1 1	
NOTE <code>Esc</code> 0 <code>VC</code> ← commands the switcher to display the current configuration.			
Firmware upload			
Upload firmware	<code>Esc</code> upload	See "SIS command firmware load" on the next page.	
Information requests			
Information request	I	<code>V[x1]X[x3]•A[x1]X[x3]</code> ↵	<code>V[x1]X[x3]</code> = V size, <code>A[x1]X[x3]</code> = A Size.
<i>Example:</i>	I	<code>V8X4•A8X4</code> ↵	8 video and 8 audio inputs and 4 video and audio outputs.
Request part number	N	<code>xx-xxx-xx</code> ↵	See appendix A for part #s.
<i>Example:</i>	N	<code>60-555-32</code> ↵	MAV 88 SVA RCA part # is 60-555-32.
Query firmware version	Q	<code>[x12]</code> ↵	
<i>Example:</i>	Q	<code>1.23</code> ↵	Sample value only.

Remote Operation, cont'd

Loading firmware using an SIS command

NOTE Firmware can be uploaded two ways:

1. Using the Matrix Switchers Control Program.
2. Using the **Esc**upload SIS command entered via a communications utility such as HyperTerminal.

Extron recommends that you upload firmware using the Matrix Switchers Control Program (see “Updating the firmware” on page 4-15) and reserve this SIS procedure for correcting firmware that has been corrupted and unable to respond to the Matrix Switchers Control Program.

Firmware can be loaded using SIS commands as follows:

1. Visit the Extron web site, www.extron.com, select the MAV switcher product category, and determine the latest firmware that is in the proper firmware set.
 - Firmware in the version 1.xx set can be replaced only by other version 1.xx firmware, with the file extension “.HEX”.
 - Firmware in the version 2.xx set can be replaced only by other version 2.xx firmware, with the file extension “.s19”.
 - The higher the version number within a firmware set, the more recent the firmware. Choose the latest version.

Select the appropriate firmware file to download and copy it to your computer. Note the folder to which you save the firmware file.

2. Start a communications utility such as HyperTerminal. Select the Comm port that is connected to the switcher’s RS-232 port. Use 9600 bits per second, 8 data bits, “none” parity, 1 stop bit, and “none” flow control.

NOTE If you are performing this procedure to recover from corrupted firmware, the switcher will respond only to the “n”, “q”, and “**Esc**upload” SIS commands.

NOTE The firmware upload can take several minutes. If HyperTerminal’s echo function is turned off, you will have no indication that the upload is progressing. If desired, turn on the echo function as follows (figure 4-3): Click File > Properties > Settings > ASCII Setup... , click in the Echo typed characters locally checkbox, and then click Ok twice.

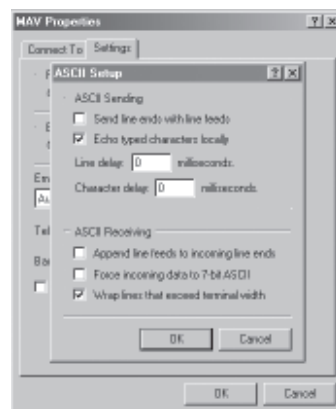

Figure 4-3 — Turn on the echo function

3. Depress the keyboard's **Esc** key and then type **upload**. The computer responds with the "Go" prompt.
4. Click *Transfer > Send text file...*
5. Click the *Files of type*: drop box and select *All files (*.*)*.
6. Navigate to the folder where you saved the firmware upgrade file. Select the file (figure 4-4).

- NOTE** Ensure that the firmware upgrade is for the MAV Series AV switcher.
- NOTE** Valid version 1.xx firmware files must have the file extension ".HEX". Any other file extension is **not** a firmware upgrade for your switcher.
- NOTE** Valid version 2.xx firmware files must have the file extension ".s19". Any other file extension is **not** a firmware upgrade for your switcher.

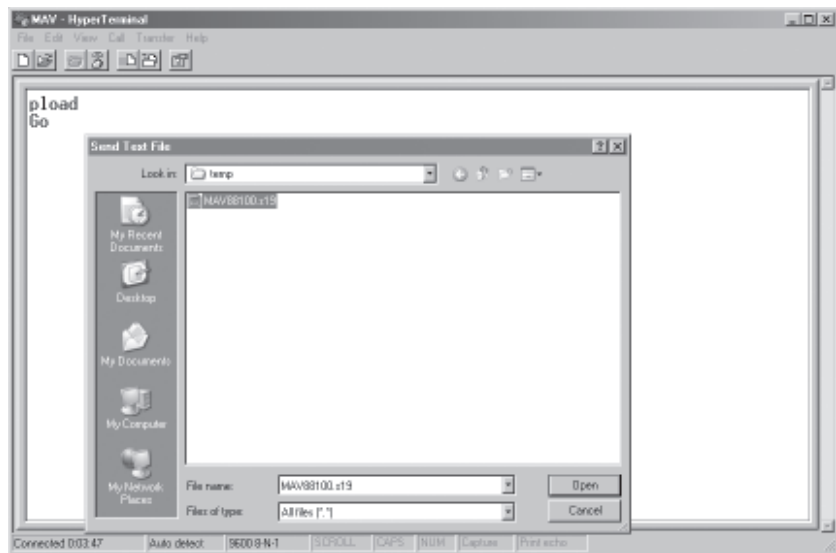

Figure 4-4— Select the firmware upgrade file

7. Click *Open*. The firmware upload begins. If you have HyperTerminal's echo function turned on, HyperTerminal will display a scroll of the text of the firmware file as it uploads to the switcher (figure 4-5).



Figure 4-5— Upload progress display

8. After several minutes, the switcher reports the startup copyright message: (C) Copyright 2004, EXTRON ELECTRONICS "MAV *nm* series", Vx.xx ↵. This message indicates that the firmware upload is complete.
9. Exit HyperTerminal.

Matrix Switchers Control Program

The Windows®-based Extron Matrix Switchers Control Program, which communicates with the switcher via the rear panel Remote RS-232 port provides an easy way to set up ties and sets of ties. The program is compatible with Windows 2000 and Windows XP.

Installing the software

The program is contained on the Extron Software Products CD-ROM, disk B. Install the software as follows:

NOTE For full functionality, install both of the following programs:

- The Matrix Switchers Control Program
- The Firmware Loader

1. Insert the CD-ROM into the drive. The installation program should start automatically. If it does not self-start, run Launch.exe from the CD.

The Extron software CD window appears (figure 4-6).

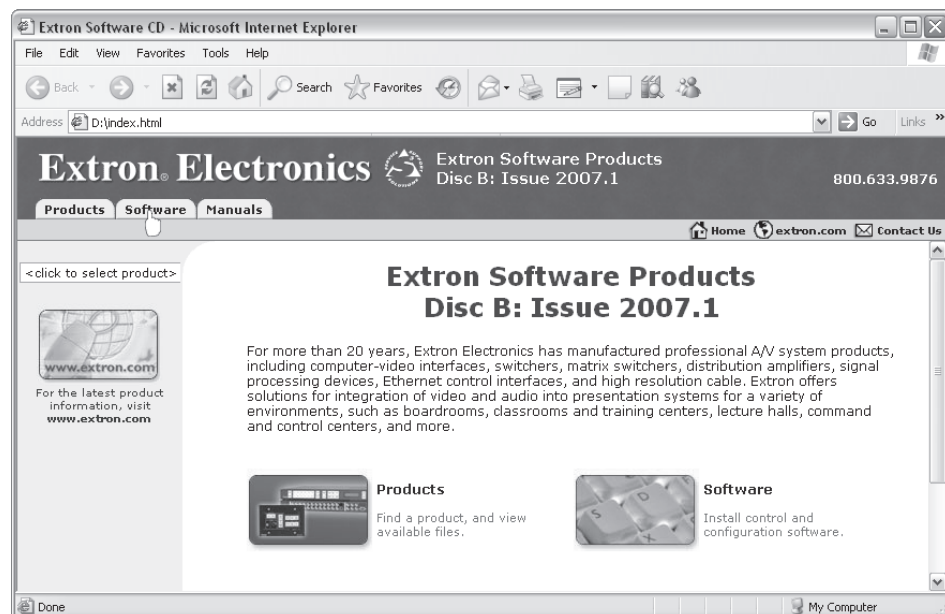

Figure 4-6 — Software CD window

2. Click the Software tab (figure 4-6).
3. Scroll to the desired program and click Install (figure 4-7).

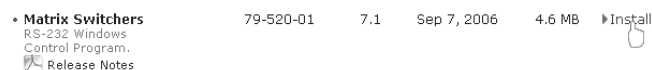

Figure 4-7 — Software installation

- Follow the on-screen instructions. By default, the Windows installation of the Matrix Switchers Control Program creates a C:\Program Files\Extron\Matrix_Switcher directory, and it places three icons into a group folder named “Extron Electronics\Matrix Switchers.” The three installed icons are:

- MATRIX Switcher+ Control Program
- MATRIX Switcher+ Help
- Uninstall MATRIX Switcher

Using the software

Overview

- To run the Matrix Switchers Control Program, double-click on the Matrix Switcher+ Control Program icon (shown at right) in the Extron Electronics group or folder. The Comm Port Selection window (figure 4-8) appears.

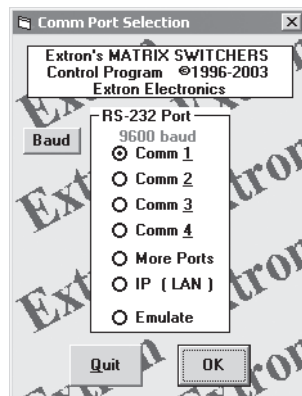
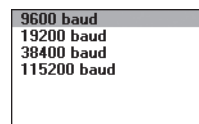

Figure 4-8 — Comm port selection window

- Choose either the comm port that is connected to the MAV switcher’s RS-232 port, or *Emulate*.

NOTE Although IP [LAN] is available for selection, the switcher does not have an Ethernet port. Do not select IP [LAN].

- If you selected a comm port, check that the baud rate displayed in the comm port selection window is the switcher’s rate of 9600. If you need to change the baud rate, click on the Baud button and double-click on 9600.



Click *OK* and proceed to step 3.

- If you selected *Emulate*, click *OK* and see “Using emulation mode” on page 4-22.

Remote Operation, cont'd

3. The Extron Matrix Switchers Control Program window (figure 4-9 and figure 4-10) displays the current configuration of the attached matrix.

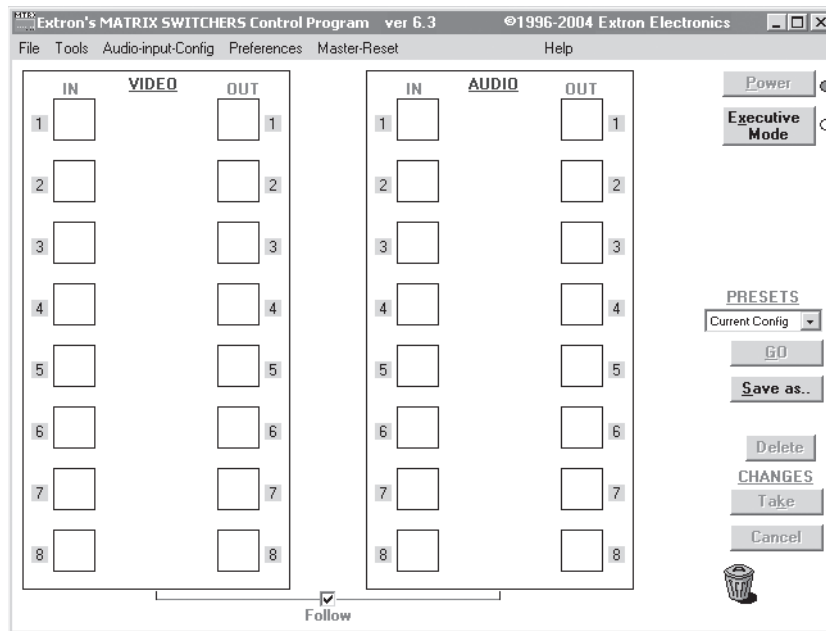

Figure 4-9 — Extron Matrix Switchers Control Program window (blank)

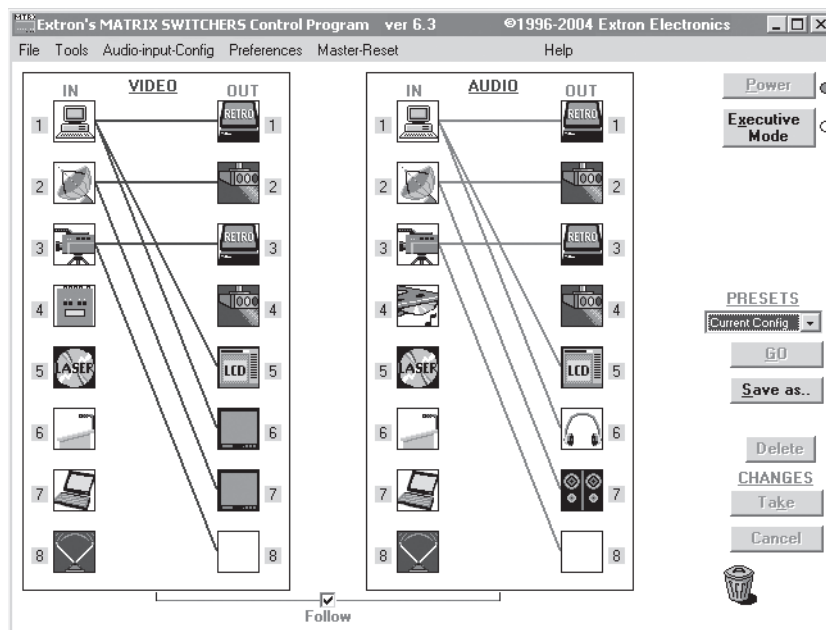

Figure 4-10 — Sample program window (complete)

4. To set up audio to follow video (audio and video have the same tie configuration), select the Follow checkbox at the bottom of the window. To set up audio to breakaway (audio and video have different tie configurations), deselect the Follow checkbox.

5. To make the control program easier to use, assign a device icon to each input and output. Click on a box that represents an input or output, and drag the desired icon onto the box from the icon palette that appears.
6. To create a tie, drag an input box to one or more output boxes. If the Take button is not grayed out, click the Take button.
7. To remove a single tie, drag the output box to its tied input box or to the trash can. To remove a set of ties, drag the input box to the trash can.

Updating the firmware

The firmware upgrade utility provides a way to replace the firmware that is coded on the switcher's control board without taking the switcher out of service.

NOTE *The MAV switcher product line has two different hardware configurations. The two configurations operate and function identically, but their firmware is mutually incompatible. Ensure that you identify and download the correct firmware set (version 1.xx or 2.xx) for your switcher or the switcher **will not operate** after the firmware update. Version 1.xx firmware files have the file extension “.HEX”. Version 2.xx firmware files have the file extension “.s19”. See steps 1 and 2, below, to identify which firmware to retrieve from the Extron web site: www.extron.com.*

NOTE *Upgrading the firmware does **not** overwrite the current configuration, presets, or the audio settings.*

Update the switcher firmware as follows:

1. Start the Matrix Switchers Control Program and connect to the MAV switcher. See “Using the software”, steps 1 through 3, starting on page 4-13.
2. Click *Help* and read the firmware version. Figure 4-11 shows a sample read of the firmware version. The most significant digit of the firmware version listed (such as “1” in figure 4-11) identifies the firmware set.

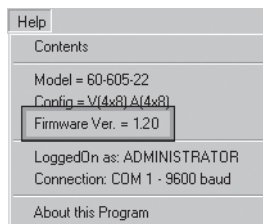

Figure 4-11 — Determining the firmware version

3. Visit the Extron web site (www.extron.com) select the MAV switcher product category, and determine the latest firmware that is in the proper firmware set.
 - Firmware in the version 1.xx set can be replaced only by other version 1.xx firmware, with the file extension “.HEX”.
 - Firmware in the version 2.xx set can be replaced only by other version 2.xx firmware, with the file extension “.s19”.
 - The higher the version number within a firmware set, the more recent the firmware. Choose the latest version.

Select the appropriate firmware file to download and copy it to your computer. Note the folder to which you save the firmware file.

Remote Operation, cont'd

4. Start the Matrix Switchers Control Program and connect to the MAV switcher. See “Using the software”, steps 1 through 3, starting on page 4-13.
5. Click on *Tools > Update firmware*.

If your switcher has version 2.xx firmware files, the Extron Firmware Loader appears (figure 4-12). Proceed to step 6a.

If your switcher has version 1.xx firmware files, an open file window appears (figure 4-13). Proceed to step 7.

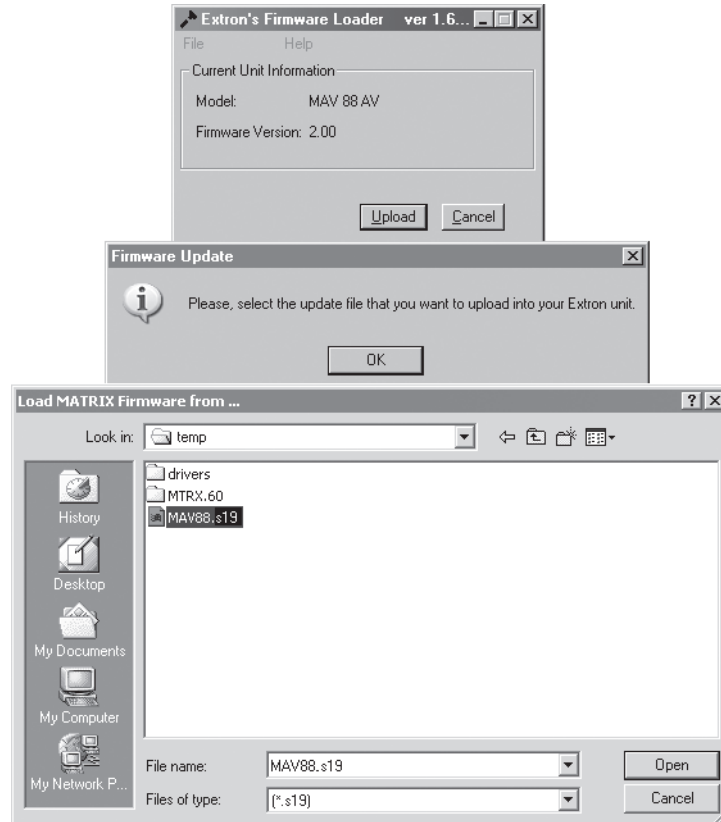

Figure 4-12 — Open window, version 2.xx firmware files

- 6a. Click *Upload*. The Firmware Update window appears.
- 6b. Click *OK*. The open file window appears. Proceed to step 7.
7. Navigate to the folder where you saved the firmware upgrade file. Select the file.

NOTE Ensure that the firmware upgrade is for the MAV Series AV switcher.

NOTE Valid version 1.xx firmware files must have the file extension “.HEX”. Any other file extension is **not** a firmware upgrade for your switcher.

NOTE Valid version 2.xx firmware files must have the file extension “.s19”. Any other file extension is **not** a firmware upgrade for your switcher.

8. Click the *Open* button.

If your switcher has version 2.xx firmware files, the Extron Firmware Loader reappears (figure 4-12). Proceed to step 9.

If your switcher has version 1.xx firmware files, proceed to step 11.

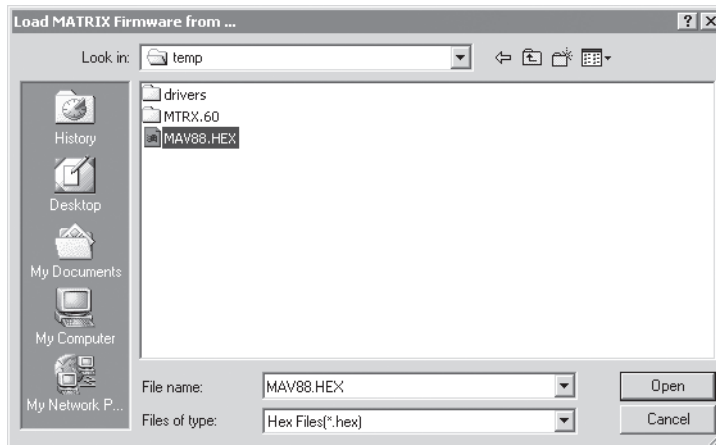

Figure 4-13 — Open window, version 1.xx firmware files

9. **Version 2.xx firmware upload** — A status bar, which shows the progress of the upload, appears in the Firmware Loader window (figure 4-14). The firmware upload to the switcher may take several minutes.

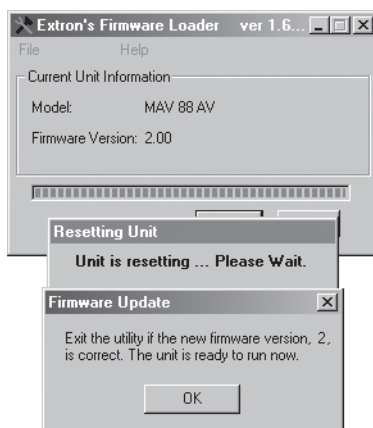

Figure 4-14 — Firmware Loader status indicator bar, switcher reset, and firmware update

Once the status bar has progressed fully from left to right across the indicator window, the firmware loader utility automatically resets the switcher (figure 4-14).

NOTE *If the firmware loader utility exits before the status bar has progressed completely across the indicator window, try using a control cable with only pins 2, 3, and 5 connected. If necessary, modify the cable by removing pins or cutting wires.*

NOTE *If the firmware loader utility exits before the status bar has progressed completely across the indicator window, the firmware may be corrupted and may no longer respond to the Matrix Switchers Control Program. In this condition, the firmware upload can be accomplished only by using the SIS commands. See “Loading firmware using an SIS command” on page 4-10.*

Remote Operation, cont'd

- When prompted, confirm that the firmware version displayed in the firmware loader is correct. Click *Ok* in the Firmware Update prompt window to exit the firmware loader utility.

- Version 1.xx firmware upload** — A status window appears that shows the progress of the download to the switcher. The firmware download may take a few minutes. The status window advances to 100% and then clears when the download is complete.



The switcher performs an initialization that blinks the front panel LEDs on and off from left to right. A successful initialization leaves the power LED on, (**audio/video models only**) the on and/or off selection of the Video and Audio LEDs the same as before the download, and all other LEDs off.

NOTE *Do not interrupt the download before the download status window shows the download is 100% complete. Interrupting the download corrupts the firmware and the switcher will not operate properly afterwards. In this condition, the firmware upload can be accomplished only by using the SIS commands. See "SIS command firmware upload", on page 4-9.*

Windows buttons, drop boxes, and the trash can

The buttons on the right side of the window perform the following functions:

Power — Unavailable for the MAV switcher, because the switcher power cannot be controlled via software.

Executive mode (front panel security lockout) — Allows you to lock out front panel operations, except for the view-only mode functions.

Presets drop box — Displays a list of up to 16 presets. You can select a preset from the list to display it in the window and either activate it (**Go**) or delete it (**Delete**).

Go — Activates the selected preset as the current configuration.

Save as — Allows the current set of ties to be saved as a preset. Enter the preset number when prompted to do so.

Delete — Allows you to delete a selected preset.

Changes - Take — Allows you to apply any changes made to the displayed configuration.

Changes - Cancel — Returns to the previous screen, undoing any changes you have made.

Trash can — Drag and drop from an input or output button to the trash can to unmake all ties associated with that input or output.



Windows menus

File menu

Save matrix settings as — Saves a complete set of up to 16 presets, plus the last active setting (preset #0), to a file. Saved settings include audio gain settings (if specified), assigned icons, and icon captions.

Restore matrix settings from — Loads and activates a previously saved setting file.

Save this-session's settings — Saves a complete set of up to 16 presets, plus the last active setting (preset #0), to overwrite the current file. Saved settings include audio gain settings (if specified), assigned icons, and icon captions.

Restore last-session's settings — Loads the icons and icon captions that were saved during the last session. If you saved the previous session's changes to disk the last time you exited the program, the ties from that session are also loaded.

Select printer — Selects the target printer.

Print tie map — Prints the tie set that is displayed on the screen.

Exit — Closes the Extron Matrix Switchers Control Program.

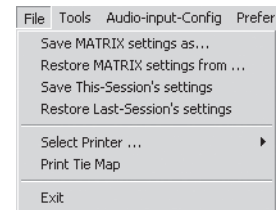

Tools menu

Assign device icons — Displays the complete set of input and output device icons. You can drag any of these icons to the input and output boxes.

Edit device palette — Allows you to add your own device icon graphics.

Audio-Input-Gain settings — Displays the Configure Audio Options window (figure 4-15), which shows the audio gain level settings for each input and allows you to change them.

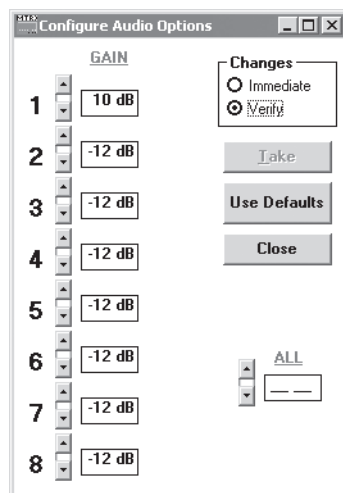
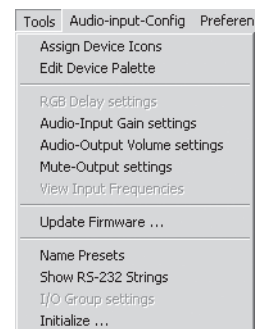

Figure 4-15 — Configure Audio Options window

Remote Operation, cont'd

Audio-Output volume settings — Displays the Mute & Output-Level window (figure 4-16), which displays the output volume level (consumer [-10 dBV] or professional [+4 dBu], for a single output or for all outputs and allows you to change it. This window also allows you to mute and unmute the video and audio output.

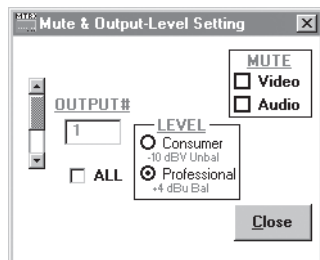

Figure 4-16 — Mute & Output-Level window

Mute-output settings — Displays the Mute & Output-Level window (figure 4-16), which allows you to mute and unmute the video and audio output for a single output or for all outputs. This window also displays the output volume level settings and allows you to change them.

Update firmware — Allows you to replace the firmware that is coded on the switcher's control board without taking the switcher out of service. See "Updating the firmware" on page 4-15.

Name presets — Allows you to name each of the 16 memory presets.

Show RS-232 strings — Displays the ASCII commands that are used by the current configuration. You can refer to these for RS-232 programming.

Initialize — Initializes and clears any or all of the following: ties, presets, audio configuration, preset titles, icon names, and icons.

Audio-input Configuration selection

Displays the Configure Audio Options window (figure 4-15), which shows the audio gain level settings for each input and allows you to change them.

Preferences menu

Immediate changes — Causes changes to take effect immediately.

Hold/verify changes — Delays implementation of changes until the Changes - Take button is pressed.

Ties as lines — Displays ties as lines (figure 4-17).

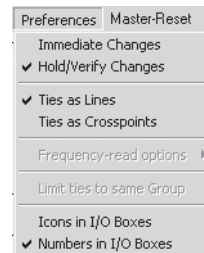

Figure 4-17 — Ties shown as lines

Ties as crosspoints — Displays ties as a grid of inputs and outputs (figure 4-18). Existing ties are indicated as orange (video and audio), green (video only), or red (audio only) boxes. New ties that will take effect when you click the *Take* button are indicated by +. Ties that will be broken when you click the *Take* button are indicated by -.

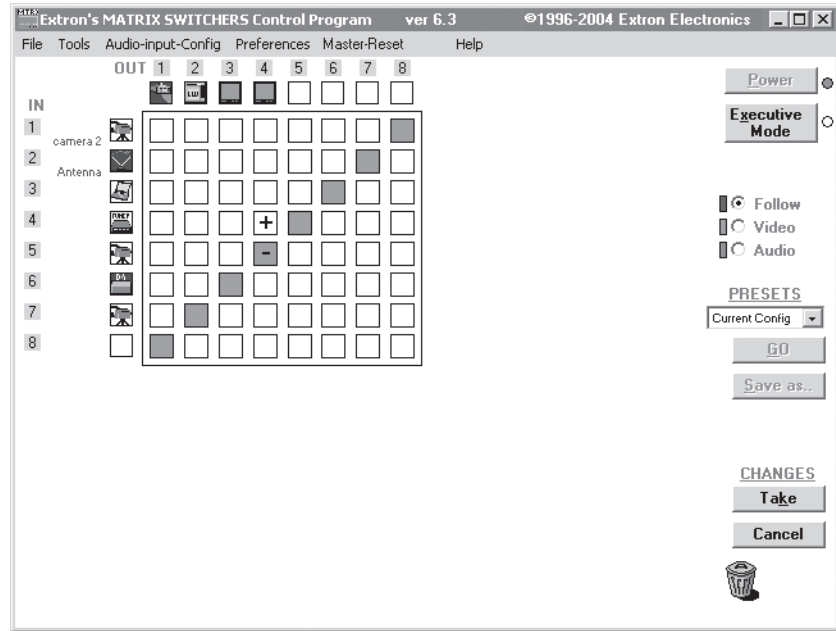



Figure 4-18 — Ties shown as crosspoints

Icons in I/O boxes — Erases any numbers in the I/O boxes in either the ties-as-lines window or ties-as-boxes window. You can place icons in the boxes. 1 

Numbers in I/O boxes — Erases any icons in the I/O boxes in either the ties-as-lines window or ties-as-boxes window and fills each box with the associated input or output number. 1 

Master-Reset selection

Clears all ties and presets, clears all video and audio mutes, sets all input audio gains to unity gain (+0dB), and sets all output levels to the factory default (-12 dB for captive screw audio connector [A] models, 0 dB for RCA audio connector [A RCA] models).

Remote Operation, cont'd

Using Emulation mode

Emulation mode allows you to set up the software without attaching the switcher to the computer. To use *Emulation* mode:

1. Double-click on the Matrix Switchers Control Program icon in the Extron Electronics group or folder.
2. Choose Emulate, and click OK.
3. Choose an emulation file to open, and click OK. The file DEMO.MTX provides a sample of a completed matrix setup. The file NEW.INI provides a blank setup to get you started.
4. Enter the file name under which you want to save any changes to the file, and click OK.
5. Select 1, 2, or 3 as the number of video boards, 1 or 2 as the number of audio boards, and MAV 84, MAV 128, MAVxxx as the matrix model for which you are preparing a configuration. Click *Ok* (figure 4-19).

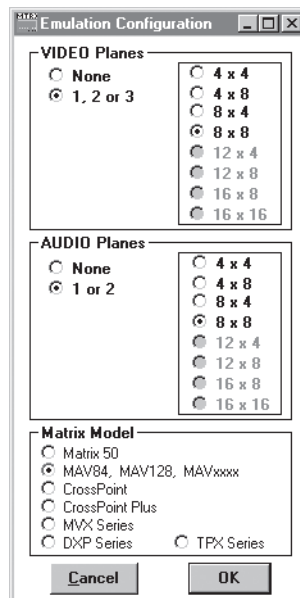

Figure 4-19 — Emulation mode configuration

6. Continue using the program as described in “Using the software”, steps 3 through 7, beginning on page 4-14.

Using the help system

For information about program features, you can access the help program in any of the following ways:

- From the Extron Electronics program folder or group, double-click the Matrix Switcher Help icon (shown at right).
- From within the Matrix Switcher Control Program, click the Help menu on the main screen.
- From within the Matrix Switcher Control Program, press the F1 key.





MAV 44 / 48 / 84 / 88 Matrix Switchers

A

Appendix A

Specifications and Part Numbers

Specifications

Part Numbers

Specifications and Part Numbers

Specifications

Video — composite video and S-video models

Routing

MAV 44 Series	4 x 4 matrix
MAV 48 Series	4 x 8 matrix
MAV 84 Series	8 x 4 matrix
MAV 88 Series	8 x 8 matrix

Gain Unity

Bandwidth 150 MHz (-3 dB), fully loaded

Differential phase error <0.1° at 3.58 MHz and 4.43 MHz

Differential gain error <0.1% at 3.58 MHz and 4.43 MHz

Crosstalk <-50 dB @ 5 MHz

Switching speed 20 ms (max.)

Video input — composite video and S-video models

Number/signal type

MAV 44 AV, MAV 44 AV RCA, MAV 48 AV, MAV 48 AV RCA	4 composite video
MAV 44 SVA, MAV 44 SVA RCA, MAV 48 SVA, MAV 48 SVA RCA	4 S-video
MAV 84 AV, MAV 84 AV RCA, MAV 88 AV, MAV 88 AV RCA, MAV 88 V	8 composite video
MAV 84 SVA, MAV 84 SVA RCA, MAV 88 SVA, MAV 88 SVA RCA	8 S-video

Connectors

MAV 44/48 composite video models	4 female BNC
MAV 44/48 S-video models	4 female 4-pin mini DIN
MAV 84/88 composite video models	8 female BNC
MAV 84/88 S-video models	8 female 4-pin mini DIN

Nominal level 1 V_{p-p} for Y of S-video, and for composite video
0.3 V_{p-p} for C of S-video

Minimum/maximum levels Analog: 0.4 V to 2.0 V_{p-p} with no offset at unity gain

Impedance 75 ohms

Return loss Composite video: <-38 dB @ 0 to 10 MHz
S-video: <-25 dB @ 0 to 10 MHz

DC offset (max. allowable) 5 V

External sync (genlock) 0.2 V to 0.4 V_{p-p}

Input coupling AC coupling only

Video output — composite video and S-video models

MAV 44 AV, MAV 44 AV RCA, MAV 84 AV, MAV 84 AV RCA	4 composite video
MAV 44 SVA, MAV 44 SVA RCA, MAV 84 SVA, MAV 84 SVA RCA	4 S-video
MAV 88 AV, MAV 88 AV RCA, MAV 88 V, MAV 48 AV, MAV 48 AV RCA	8 composite video
MAV 88 SVA, MAV 88 SVA RCA, MAV 48 SVA, MAV 48 SVA RCA	8 S-video

Connectors

MAV 44/84 composite video models	4 female BNC
MAV 44/84 S-video models	4 female 4-pin mini DIN
MAV 48/88 composite video models	8 female BNC
MAV 48/88 S-video models	8 female 4-pin mini DIN
Nominal level	1 Vp-p for Y of S-video, and for composite video 0.3 Vp-p for C of S-video
Minimum/maximum levels	0.4 V to 2.0 Vp-p (follows input)
Impedance	75 ohms
Return loss	S-video: <-25 dB @ 5 MHz Composite video: <-40 dB @ 5 MHz
DC offset	15 mV typical (per output enabled with 70 ohm termination) with input at 0 offset
Switching type	Vertical interval

Sync — composite video and S-video models

Genlock connectors	2 BNC female
Standards	NTSC 3.58, NTSC 4.43, PAL, SECAM

Audio — audio models

Routing

MAV 44 Series	4 x 4 stereo matrix
MAV 48 Series	4 x 8 stereo matrix
MAV 84 Series	8 x 4 stereo matrix
MAV 88 Series	8 x 8 stereo matrix
Gain	Adjustable; the default is unity. Unity gain occurs for all RCA connector models. In all other models with captive screw connectors, unity gain occurs when the switcher is configured for balanced output.
Frequency response	20 Hz to 20 kHz, ± 0.5 dB
THD + Noise	1% @ 1 kHz, 0.3% @ 20 kHz at nominal level
S/N	90 dB at maximum output (unweighted)
Crosstalk	<-65 dB @ 20 kHz, <-80 dB @ 1 kHz or below 60 Hz, fully loaded
Stereo channel separation	>80 dB @ 20 Hz to 20 kHz
CMRR	>75 dB @ 20 Hz to 20 kHz

Audio input — audio models

Number/signal type

MAV 44 AV, MAV 44 SVA, MAV 48 AV, MAV 48 SVA	4 stereo, balanced/unbalanced
MAV 44 AV RCA, MAV 44 SVA RCA, MAV 48 AV RCA, MAV 48 SVA RCA	4 stereo, unbalanced
MAV 84 AV, MAV 84 SVA, MAV 88 AV, MAV 88 SVA	8 stereo, balanced/unbalanced
MAV 84 AV RCA, MAV 84 SVA RCA, MAV 88 AV RCA, MAV 88 SVA RCA	8 stereo, unbalanced

Specifications and Part Numbers, cont'd

Connectors

MAV 44 AV, MAV 44 SVA, MAV 48 AV, MAV 48 SVA
(4) 3.5 mm captive screw connectors, 5-pole

MAV 44 AV RCA, MAV 44 SVA RCA, MAV 48 AV RCA, MAV 48 SVA RCA
4 pairs of RCA female connectors

MAV 84 AV, MAV 84 SVA, MAV 88 AV, MAV 88 SVA
(8) 3.5 mm captive screw connectors, 5-pole

MAV 84 AV RCA, MAV 84 SVA RCA, MAV 88 AV RCA, MAV 88 SVA RCA
8 pairs of RCA female connectors

Impedance >18k ohms unbalanced, 24k ohms balanced, DC coupled

Nominal level Configurable: +4 dBu (1.23 V, professional level) or -10 dBV (316 mV, consumer level)

Maximum level >+20 dBu (captive screw models) at 1% THD+N
>+14 dBu (RCA models) at 1% THD+N

Input gain adjustment -18 dB to +10 dB, adjustable per input; default = 0 dB. (This is referenced to the internal bus signal level. It can be verified by measuring the unbalanced output level when the output level is set to "Consumer".)

NOTE 0 dBu = 0.775 V(rms), 0 dBV = 1 V(rms), 0 dBV ≈ 2 dBu

Audio output — audio models

Number/signal type

MAV 44 AV, MAV 44 SVA, MAV 84 AV, MAV 84 SVA
4 stereo, balanced/unbalanced

MAV 44 AV RCA, MAV 44 SVA RCA, MAV 84 AV RCA, MAV 84 SVA RCA
4 stereo, unbalanced

MAV 88 AV, MAV 88 SVA, MAV 48 AV, MAV 48 SVA
8 stereo, balanced/unbalanced

MAV 88 AV RCA, MAV 88 SVA RCA, MAV 48 AV RCA, MAV 48 SVA RCA
8 stereo, unbalanced

Connectors

MAV 44 AV, MAV 44 SVA, MAV 84 AV, MAV 84 SVA
(2) 3.5 mm captive screw connectors, 10-pole

MAV 44 AV RCA, MAV 44 SVA RCA, MAV 84 AV RCA, MAV 84 SVA RCA
4 pairs of RCA female

MAV 88 AV, MAV 88 SVA, MAV 48 AV, MAV 48 SVA
(4) 3.5 mm captive screw connectors, 10-pole

MAV 88 AV RCA, MAV 88 SVA RCA, MAV 48 AV RCA, MAV 48 SVA RCA
8 pairs of RCA female

Impedance 50 ohms unbalanced, 100 ohms balanced

Gain error <±0.1 dB channel to channel

Nominal level Configurable: +4 dBu (1.23 V, professional level) or -10 dBV (316 mV, consumer level)

Maximum level (Hi-Z) >+20 dBu, balanced; >+18 dBu, unbalanced at 1%THD+N at default settings

Maximum level (600 ohm) >+19 dBm, balanced; >+13 dBm, unbalanced at 1%THD+N at default settings

Control/remote — switcher

Serial control port	RS-232, 9-pin female D connector
Baud rate and protocol	9600 baud, 8 data bits, 1 stop bit, no parity
Serial control pin configurations	2 = TX, 3 = RX, 5 = GND, 9 = hardwired IR
IR controller module	IR 501 remote control (optional)
Program control	Extron's control/configuration program for Windows® Extron's Simple Instruction Set (SIS™)

General

Power	100 VAC to 240 VAC, 50/60 Hz, 15 watts, internal, autoswitchable
Temperature/humidity	Storage: -40 to +158 °F (-40 to +70 °C) / 10% to 90%, noncondensing Operating: +32 to +122 °F (0 to +50 °C) / 10% to 90%, noncondensing
Cooling	Convection, vented, vents on top and side panels
Rack mount	Yes, with included brackets, part #70-077-03 Also furniture mountable with an optional under-desk mounting kit, part #70-222-01
Enclosure type	Metal
Enclosure dimensions	1.75" H x 17.4" W x 8.5" D (1U high, full rack wide) 4.4 cm H x 44.2 cm W x 21.6 cm D (Depth excludes connectors. Width excludes rack ears.)
Product weight	7.0 lbs (3.2 kg)
Shipping weight	10 lbs (5 kg)
Vibration	ISTA 1A in carton (International Safe Transit Association)
Listings	UL, CUL
Compliances	CE, FCC Class A, VCCI, AS/NZS, ICES
MTBF	30,000 hours
Warranty	3 years parts and labor

NOTE All nominal levels are at $\pm 10\%$.

NOTE Specifications are subject to change without notice.

Specifications and Part Numbers, cont'd

Part Numbers

MAV Series AV switchers

Extron Part	Part #
MAV 44 SVA S-video and audio switcher	60-553-22
MAV 44 SVA RCA S-video and audio switcher (RCA connectors)	60-553-32
MAV 44 AV composite video and audio switcher	60-553-21
MAV 44 AV RCA composite video and audio switcher (RCA connectors)	60-553-31
MAV 48 SVA S-video and audio switcher	60-605-22
MAV 48 SVA RCA S-video and audio switcher (RCA connectors)	60-605-32
MAV 48 AV composite video and audio switcher	60-605-21
MAV 48 AV RCA composite video and audio switcher (RCA connectors)	60-605-31
MAV 84 SVA S-video and audio switcher	60-554-22
MAV 84 SVA RCA S-video and audio switcher (RCA connectors)	60-554-32
MAV 84 AV composite video and audio switcher	60-554-21
MAV 84 AV RCA composite video and audio switcher (RCA connectors)	60-554-31
MAV 88 SV S-video video switcher	60-555-02
MAV 88 SVA S-video and audio switcher	60-555-22
MAV 88 SVA RCA S-video and audio switcher (RCA connectors)	60-555-32
MAV 88 V composite video switcher	60-555-01
MAV 88 AV composite video and audio switcher	60-555-21
MAV 88 AV RCA composite video and audio switcher (RCA connectors)	60-555-31

Included parts

Extron Part	Part #
Rack/desk mounting kit	70-077-03
Captive screw audio connectors (captive screw audio (A) models only)	
Tweezer	
IEC power cord	
MAV Series AV Matrix Switcher User's Manual	
Extron Software Products CD	

Replacement parts

Replacement parts	Part #
Button and cap diffuser kit	70-352-01
Button overlays	100-196-01

Optional accessories

Extron Part	Part #
Captive screw connectors with tail (qty. 10)	100-457-01
IR 501 small matrix universal remote control	70-336-01
MBU 149 1U enclosure under-desk mounting kit	70-222-01
RCA-to-BNC adapter	100-229-01
SVHS - BNC adapter	26-353-01
MKP 3000	
Black	60-708-02
White	60-708-03
RAL 9010 white	60-708-05
MKP 3000 MAAP, black	60-709-02
MKP 3000 MAAP, white	60-709-03
MKP 3000 MAAP, RAL 9010 white	60-709-05
MKP 3000 L	60-709-22
MKP 10 MAAP	
Black	60-710-10
White	60-710-20
RAL 9010 white	60-710-50
MKP 2000	
Black	60-682-02
White	60-682-03
RAL 9010 white	60-682-05
MKP 1000	
Gray kit with audio	60-239-01
Black	60-239-02
White	60-239-03
MKP 1000M (primary)	60-298-01
MKP 1000S (secondary)	60-298-02

Cables

When using signals with a scanning frequency of 15-125 kHz and running distances of 100 feet or more, use high resolution BNC cables for maximum performance.

Bulk cable

S-video mini high resolution cable	Part #
BNC-2 Mini HR, 250' (76.2 meters)	22-123-02
BNC-2 Mini HR, 500' (152.4 meters)	22-123-03
Plenum BNC-2 Mini HR, 250' (76.2 meters)	22-129-02
Plenum BNC-2 Mini HR, 500' (152.4 meters)	22-129-03
BNC Mini HR crimp connectors, qty. 50	100-074-51
RG6 super high resolution cable	Part #
RG6-1/500 , 500'	22-098-02
RG6-1/1000 , 1000'	22-098-03
BNC male RG6 crimp connectors, qty. 50	100-260-01
RG59 High Resolution Cable	Part #
RG59/500 , 500'	22-145-02
RG59/1000, 1000'	22-145-03
RG59P/500, 500'	22-146-02
RG59P/1000, 1000'	22-146-03
RG59/HR male crimp connectors, qty. 50	100-404-51

NOTE Bulk cable in lengths up to 5000' (1524 meter) rolls is available with or without connectors.

Specifications and Part Numbers, cont'd

Assorted connectors

BNC connectors	Part #
BNC bulkhead connectors, qty. 50 (for custom wall plates)	100-076-51

Pre-cut cables

S-video cable is terminated with 4-pin mini DIN connectors on both ends. All Extron BNC cables have male connectors on both ends. A plenum version of the BNC-5 Mini HR cable is also available.

S-video Cable	Part #
Male-to-male cable	
MHR-2 SVM-M/6 (6 feet/1.8 meters)	26-316-02
MHR-2 SVM-M/12 (12 feet/3.7 meters)	26-316-03
MHR-2 SVM-M/20 (20 feet/6.1 meters)	26-316-01
MHR-2 SVM-M/30 (30 feet/9.1 meters)	26-316-04
MHR-2 SVM-M/50 (50 feet/15.2 meters)	26-316-05
MHR-2 SVM-M/75 (75 feet/23.0 meters)	26-316-06
MHR-2 SVM-M/100 (100 feet/30.0 meters)	26-316-07
MHR-2P SVM-M/6 plenum (6 feet/1.8 meters)	26-522-01
MHR-2P SVM-M/12 (12 feet/3.7 meters)	26-522-02
MHR-2P SVM-M/20 (20 feet/6.1 meters)	26-522-03
MHR-2P SVM-M/30 (30 feet/9.1 meters)	26-522-04
MHR-2P SVM-M/50 (50 feet/15.2 meters)	26-522-05
MHR-2P SVM-M/75 (75 feet/23.0 meters)	26-522-06
MHR-2P SVM-M/100 (100 feet/30.0 meters)	26-522-07
Male-to-female cable	
MHR-2 SVM-F 6' (6 feet/1.8 meters)	26-542-02
MHR-2 SVM-F 12' (12 feet/3.7 meters)	26-542-03
MHR-2 SVM-F 20' (20 feet/6.1 meters)	26-542-01
MHR-2 SVM-F 30' (30 feet/9.1 meters)	26-542-04
MHR-2 SVM-F 50' (50 feet/15.2 meters)	26-542-05
MHR-2 SVM-F 75' (75 feet/23.0 meters)	26-542-06
MHR-2 SVM-F 100' (100 feet/30.0 meters)	26-542-07
MHR-2P SVM-F 6' plenum (6 feet/1.8 meters)	26-543-01
MHR-2P SVM-F 12' plenum (12 feet/3.7 meters)	26-543-02
MHR-2P SVM-F 20' plenum (20 feet/6.1 meters)	26-543-03
MHR-2P SVM-F 30' plenum (30 feet/9.1 meters)	26-543-04
MHR-2P SVM-F 50' plenum (50 feet/15.2 meters)	26-543-05
MHR-2P SVM-F 75' plenum (75 feet/23.0 meters)	26-543-06
MHR-2P SVM-F 100' plenum (100 feet/30.0 meters)	26-543-07
Composite video Cable	
RG6-1 3' (3 feet/0.9 meters)	26-383-01
RG6-1 6' (6 feet/1.8 meters)	26-383-12
RG6-1 12' (12 feet/3.7 meters)	26-383-07
RG6-1 25' (25 feet/7.6 meters)	26-383-04
RG6-1 35' (35 feet/10.7 meters)	26-383-13
RG6-1 50' (50 feet/15.2 meters)	26-383-05
RG6-1 75' (75 feet/22.9 meters)	26-383-06
RG6-1 100' (100 feet/30.5 meters)	26-383-03
RG6-1 150' (150 feet/45.7 meters)	26-383-08
RG6-1 200' (200 feet/61.0 meters)	26-383-09
RG6-1 250' (250 feet/76.2 meters)	26-383-10
RG6-1 300' (300 feet/91.4 meters)	26-383-11

Extron's Warranty

Extron Electronics warrants this product against defects in materials and workmanship for a period of three years from the date of purchase. In the event of malfunction during the warranty period attributable directly to faulty workmanship and/or materials, Extron Electronics will, at its option, repair or replace said products or components, to whatever extent it shall deem necessary to restore said product to proper operating condition, provided that it is returned within the warranty period, with proof of purchase and description of malfunction to:

**USA, Canada, South America,
and Central America:**

Extron Electronics
1001 East Ball Road
Anaheim, CA 92805, USA

Asia:

Extron Electronics, Asia
135 Joo Seng Road, #04-01
PM Industrial Bldg.
Singapore 368363

Europe, Africa, and the Middle East:

Extron Electronics, Europe
Beeldschermweg 6C
3821 AH Amersfoort
The Netherlands

Japan:

Extron Electronics, Japan
Kyodo Building
16 Ichibancho
Chiyoda-ku, Tokyo 102-0082
Japan

This Limited Warranty does not apply if the fault has been caused by misuse, improper handling care, electrical or mechanical abuse, abnormal operating conditions or non-Extron authorized modification to the product.

If it has been determined that the product is defective, please call Extron and ask for an Applications Engineer at (714) 491-1500 (USA), 31.33.453.4040 (Europe), 65.383.4400 (Asia), or 81.3.3511.7655 (Japan) to receive an RA# (Return Authorization number). This will begin the repair process as quickly as possible.

Units must be returned insured, with shipping charges prepaid. If not insured, you assume the risk of loss or damage during shipment. Returned units must include the serial number and a description of the problem, as well as the name of the person to contact in case there are any questions.

Extron Electronics makes no further warranties either expressed or implied with respect to the product and its quality, performance, merchantability, or fitness for any particular use. In no event will Extron Electronics be liable for direct, indirect, or consequential damages resulting from any defect in this product even if Extron Electronics has been advised of such damage.

Please note that laws vary from state to state and country to country, and that some provisions of this warranty may not apply to you.



www.extron.com

Extron Electronics, USA
1230 South Lewis Street
Anaheim, CA 92805
800.633.9876 714.491.1500
FAX 714.491.1517

Extron Electronics, Europe
Beeldschermweg 6C
3821 AH Amersfoort, The Netherlands
+800.3987.6673 +31.33.453.4040
FAX +31.33.453.4050

Extron Electronics, Asia
135 Joo Seng Rd. #04-01
PM Industrial Bldg., Singapore 368363
+800.7339.8766 +65.6383.4400
FAX +65.6383.4664

Extron Electronics, Japan
Kyodo Building, 16 Ichibancho
Chiyoda-ku, Tokyo 102-0082
Japan
+81.3.3511.7655 FAX +81.3.3511.765