

User's Guide



DVI-RGB 100 Direct Digital Video to RGB Video Converter

Overview

The DVI-RGB 100 converter converts direct digital video to analog RGB video. The converter accepts a single link of digital-only Digital Visual Interface (DVI-D) video from a computer, or other digital video source device, on a standard 25-pin female DVI-D connector. Digital Flat Panel (DFP) video can be input via a DFP-to-DVI adapter. The converter outputs analog RGBHV, RGBS, or RGSB video on five, four, or three female BNC connectors. The converter also buffers the DVI input and loops it through on a DVI connector for use by a local monitor (figure 1).

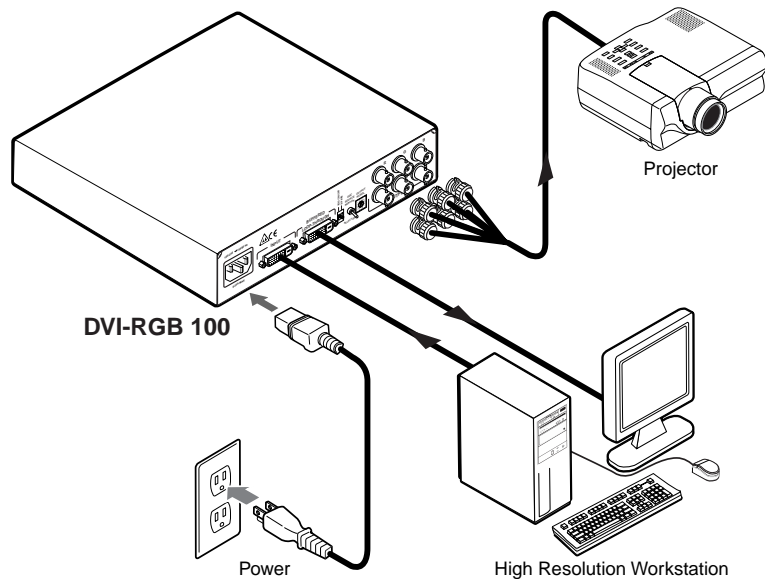

Figure 1 — Typical DVI-RGB 100 application

The video source uses the bidirectional Display Data Channel (DDC) to determine the video resolution and refresh rate. The video source can obtain the rate directly from the local monitor or the user can select 1 of 14 resolutions and rates built into the converter.

Level and peaking adjustments allow the user to enhance the RGB video output for transmission across long distances.

The DVI-RGB 100 is rack mountable and has an internal switching power supply for worldwide power compatibility.

Rear Panel Connections and Controls

- ① **Input connector** — Connect a single link of direct digital video to this 25-pin DVI-D connector (figure 2) using the included cable.
- ② **Buffered Loop-through connector** — If desired, connect a direct digital local monitor to this 25-pin DVI-D connector.

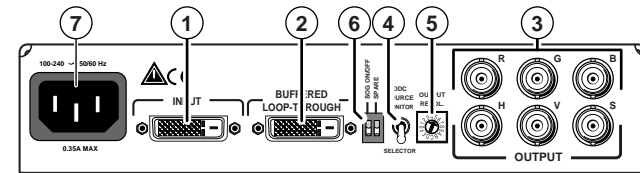
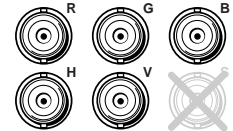

Figure 2 — DVI-RGB 100 rear panel

- ③ **Output connectors** — Connect an RGB display to these female BNC connectors.

For RGBHV video — Connect to five BNC connectors as shown at right.

Ensure that the SOG On/Off switch (⑥) is turned off.



For RGBS video — Connect to four BNC connectors as shown at right. Ensure that the SOG On/Off switch (⑥) is turned off.

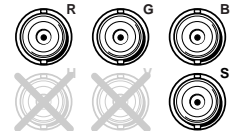

For RGSB video — Connect to three BNC connectors as shown at right. Ensure that the SOG On/Off switch (⑥) is turned on.

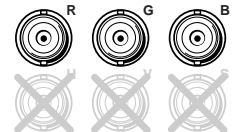

- ④ **DDC Source switch** — Set this switch to the Monitor (**up**) position to connect the DDC channel between the direct digital video source and the local monitor.

Set this switch to the Selector (**down**) position to connect the DDC channel between the direct digital video source and the built-in DVI-RGB 100 DDC logic.

- ⑤ **Output Resol.(ution) rotary switch** — If the DDC Source switch (④) is in the Selector position, set this switch to the appropriate position to select the desired direct digital video resolution and refresh rate. The table below identifies the switch positions and the associated resolutions and vertical refresh rates.

Pos.	Resolution	V. Rate	Pos.	Resolution	V. Rate	Pos.	Resolution	V. Rate
0	640x480	60	5	852x480	60	A	1280x1024	60
1	640x480	75	6	1024x768	60	B	1280x1024	75
2	800x600	60	7	1024x768	75	C	1365x1024	60
3	800x600	75	8	1024x1024	60	D	1280x720	60
4	848x480	60	9	1280x765	56	E, F	Spare	

Installation

NOTE Many monitors will not support all of the resolutions and refresh rates shown. If you get no display, try a different rate.

- 6 **SOG (Sync on Green) On/Off switch**— Set this switch to the On (up) position to enable SOG for RGsB video.

Set this switch to the Off (down) position to disable SOG for RGSB or RGBHV video.

- 7 **AC power connector** — Plug a standard IEC power cord into this connector to connect the converter to a 100 to 240VAC, 50 Hz or 60 Hz power source.

Installation

1. Power off the computer and its local monitor.
2. For optional rack mounting, mount the converter on a 19" 1U Universal Rack Shelf (Extron part #60-190-01) (figure 3).

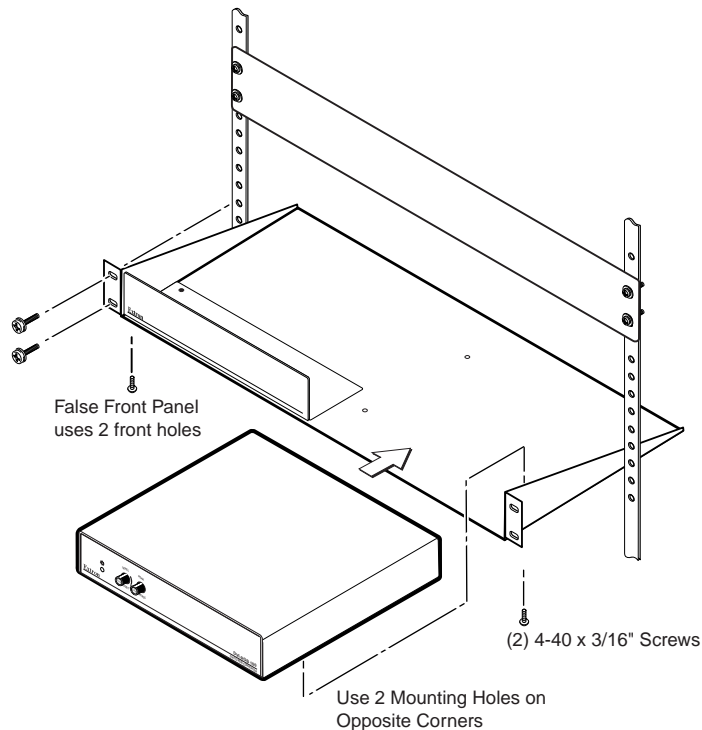

Figure 3 — Rack mounting the DVI-RGB 100

- a. Remove the rubber feet from the case if installed.
- b. Mount the converter on the rack shelf, using two 4-40 x 3/16 screws in opposite (diagonal) corners.

- c. Install a blank panel (included in the rack kit) or another 1U half-rack unit on the unused side of the rack.
3. Connect the input, loop-through and output cables. See *Rear Panel Connections and Controls*.

NOTE The maximum permissible length of the DVI input and output cables is 16.4 feet (5 meters). Ensure that the cables do not exceed the maximum permissible length, otherwise images may be distorted or missing. Extron does not guarantee signal integrity beyond 16.4 feet.

4. Configure the DDC, Output Resolution, and SOG switches. See *Rear Panel Connections and Controls*.
5. Connect power to the DVI-RGB 100.
6. Power on the local monitor and other connected display device(s).
7. Power on the computer

Front Panel Controls and Indicator

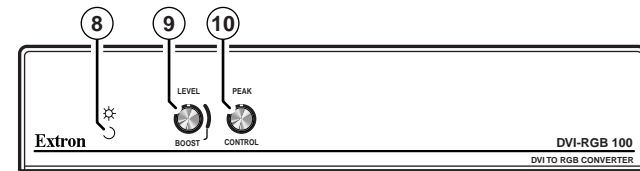

Figure 4 — DVI-RGB 100 front panel

- 8 **Power LED** — The Power LED lights when the DVI-RGB 100 is receiving power.
- 9 **Level Boost control** — The Level Boost control alters the brightness of the picture on the RGB output. Judge the adjustment visually by looking at the display.
 - At the minimum level setting (the counterclockwise limit of this control), the converter outputs video at 0.5 volts p-p.
 - At the control's midpoint, the converter outputs video at 0.7 volts p-p (unity level).
 - At the maximum level setting (the clockwise limit of this control), the converter outputs video at 1.45 volts p-p.

Select a level setting of 0.7 volts and above to compensate for the signal level decrease that occurs with long cables. Set the level at the maximum setting for cable lengths over 500 feet.

NOTE Level Boost has no affect on the DVI output of the Buffered Loop-through connector.

Indicators and Specifications

- ⑩ **Peak(ing) control** — The Peaking control affects the sharpness of the picture on the RGB output. Increased peaking can compensate for detail (mid- and high-frequency) loss from low bandwidth system components or capacitance in long cables. The minimum setting (at the counterclockwise limit) provides no peaking. The maximum setting (at the clockwise limit) provides 100% peaking. Adjust this control while viewing the displayed image to obtain the optimum picture sharpness.

NOTE *Peaking has no affect on the DVI output of the Buffered Loop-through connector.*

Operation

After the DVI-RGB 100 and its connected devices are powered up, the system is fully operational. If any problems are encountered, verify that the cables are routed and connected properly.

NOTE *The computer reads the DDC on power up to determine the direct digital video resolution and refresh rate to output. Ensure that the local DVI monitor and the RGBHV monitor can both display the selected resolution and refresh rate, otherwise images may be distorted or missing.*

NOTE *Ensure that the computer and local DVI monitor are connected to the DVI-RGB 100, and the DVI-RGB 100 and local monitor have power applied, before applying power to the computer. If the other devices are not turned on before the computer is, the image will not appear.*

DVI Connector Pin Assignments

Figure 5 and the table below define the DVI pin assignments.

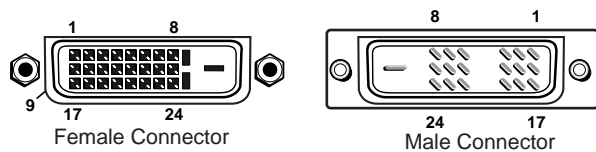

Figure 5 — DVI connectors

DVI/DFP signals run at a very high frequency and are especially prone to bad video connections, too many adapters, or excessive cable length. To avoid the loss of an image or jitter, follow these guidelines:

- Do not exceed 16.4 feet (5 meters) on the input or buffered loop-through of the converter.

NOTE *The missing connectors on the included DVI cable are not required for the single link of DVI-D data supported by the DVI-RGB 100. These pins are grayed out on the following table.*

Pin	Signal	Pin	Signal	Pin	Signal
1	TMDS Data 2-	9	TMDS Data 1-	17	TMDS Data 0-
2	TMDS Data 2+	10	TMDS Data 1+	18	TMDS Data 0+
3	TMDS Data 2/4 Shield	11	TMDS Data 1/3 Shield	19	TMDS Data 0/5 Shield
4	TMDS Data 4-	12	TMDS Data 3-	20	TMDS Data 5-
5	TMDS Data 4+	13	TMDS Data 3+	21	TMDS Data 5+
6	DDC Clock	14	+5 V Power	22	TMDS Clock Shield
7	DDC Data	15	Ground (+5 V)	23	TMDS Clock+
8	No Connection	16	Hot Plug Detect	24	TMDS Clock-

- Use only the cable designed for DVI signals supplied by Extron.
- Limit or avoid the use of adapters.
- Use only approved DVI/DFP connectors.

CAUTION *Use only cables specifically intended for DVI or DFP interfaces. Use of non-DVI or non-DFP cables or modified cables can cause the DVI-RGB 100 to fail.*

Specifications

Video

Bit rate (pixel bandwidth)	1.6 gigabits/second/color
Pixel data bit depth	24 bit
Control data bit depth	6 bit
Maximum resolutions	1280 x 1024 at 85 Hz, 1600 x 1200 at 60 Hz

Video input

Number/signal type	1 DVI-D digital video
Connectors	1 DVI-D female (DVI input) 1 DVI-D female (DVI loop through)
Minimum/maximum levels	0.5V to 1.0V p-p
Impedance	50 ohms
Maximum DC offset	±0.5V

Video output

Number/signal type	1 RGBHV, RGBS, RGsB
Connectors	6 BNC female

Minimum/maximum levels 0.7V to 1.4V p-p (continuously adjustable)
 Impedance 75 ohms
 Return loss -35dB @ 5 MHz
 DC offset ±5mV maximum with input at 0 offset

Sync

Output type RGBHV, RGBS, RGsB
 Output level TTL (5V p-p) (unterminated)
 Output impedance 75 ohms
 Polarity Positive or negative (follows input)

General

Power 100VAC to 240VAC, 50/60 Hz, 25 watts, internal,
 auto-switchable.
 Product requires 0.15 A to 0.3 A.
 Temperature/humidity Storage -40° to +158°F (-40° to +70°C) / 10% to
 90%, non-condensing
 Operating +32° to +122°F (0° to +50°C) / 10% to
 90%, non-condensing
 Rack mount Yes, with optional rack shelf, part #60-190-01
 Enclosure type Metal
 Enclosure dimensions 1.7" H x 8.7" W x 6.0" D (1U high, half rack
 width)
 4.3 cm H x 22.1 cm W x 15.2 cm D
 (Depth excludes connectors and knobs.)
 Product weight 1.6 lbs (0.7 kg)
 Shipping weight 4 lbs (1.8 kg)
 Vibration ISTA/NSTA 1A in carton (International Safe
 Transit Association)
 Listings UL, CUL
 Compliances CE, FCC Class A, VCCI, AZ/NZS, ICES
 MTBF 30,000 hours
 Warranty 3 years parts and labor

NOTE Specifications are subject to change without notice.

Optional Adapters and Cables

- 26-497-01 DVI (male), DFP (female)
- 26-498-01 DVI (female), DFP (male)
- 26-535-01 DVI-D M-M extension cable, 6.6'
- 26-535-02 DVI-D M-M extension cable, 9.9'



www.extron.com

Extron Electronics, USA
 1230 South Lewis Street
 Anaheim, CA 92805
 USA
 714.491.1500
 Fax 714.491.1517

Extron Electronics, Europe
 Beeldschermweg 6C
 3821 AH Amersfoort
 The Netherlands
 +31.33.453.4040
 Fax +31.33.453.4050

Extron Electronics, Asia
 135 Joo Seng Road, #04-01
 PM Industrial Building
 Singapore 368363
 +65.6383.4400
 Fax +65.6383.4664

Extron Electronics, Japan
 Daisan DMJ Building 6F
 3-9-1 Kudan Minami
 Chiyoda-ku, Tokyo 102-0074 Japan
 +81.3.3511.7655
 Fax +81.3.3511.7656